

Frequency Inverter

CFW-11

User's Manual

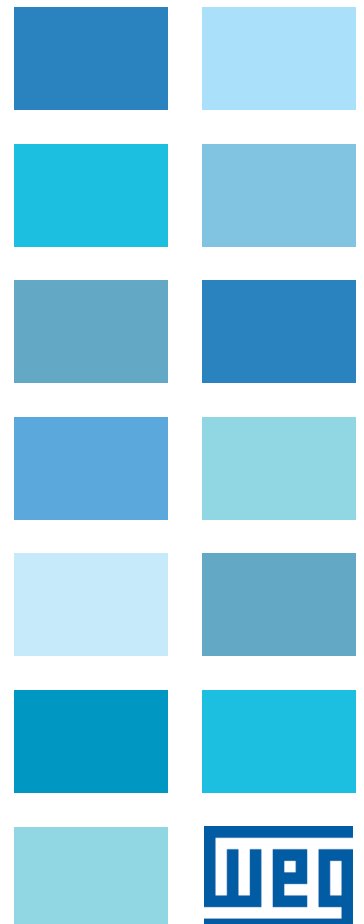



CFW-11 VECTRUE INVERTER

FREQUENCY INVERTER MANUAL

Series: CFW-11

Language: English

Document: 10000063093 / 06

Models: 6...105 A / 200...240 V

3,6...88 A / 380...480 V

Summary of Revisions

Versión	Revision	Description
-	R01	First edition
-	R02	General revision
-	R03	Setting in Table 3.6 on page 3-30
-	R04	General revision
-	R05	General revision
-	R06	It was added: The Section 3.3 SAFETY STOP FUNCTION on page 3-35 Modifications of Slot 4 and Slot 5 New accessory models Additional information on the HMI New models of recommended fuses General revision

1 SAFETY INSTRUCTIONS	1-1
1.1 SAFETY WARNINGS IN THE MANUAL.....	1-1
1.2 SAFETY WARNINGS IN THE PRODUCT.....	1-1
1.3 PRELIMINARY RECOMMENDATIONS	1-2
2 GENERAL INSTRUCTIONS	2-1
2.1 ABOUT THE MANUAL	2-1
2.2 TERMS AND DEFINITIONS	2-2
2.3 ABOUT THE CFW-11	2-5
2.4 IDENTIFICATION LABELS FOR THE CFW-11	2-8
2.5 RECEIVING AND STORAGE.....	2-10
3 INSTALLATION AND CONNECTION	3-1
3.1 MECHANICAL INSTALLATION	3-1
3.1.1 Installation Environment	3-1
3.1.2 Mounting Considerations	3-2
3.1.3 Cabinet Mounting	3-5
3.1.4 Access to the Control and Power Terminal Strips	3-6
3.1.5 HMI Installation at the Cabinet Door or Command Panel (Remote HMI)	3-9
3.2 ELECTRICAL INSTALLATION	3-9
3.2.1 Identification of the Power and Grounding Terminals.....	3-10
3.2.2 Power/Grounding Wiring and Fuses	3-12
3.2.3 Power Connections.....	3-16
3.2.3.1 Input Connections	3-17
3.2.3.1.1 Power Supply Capacity	3-18
3.2.3.1.2 IT Networks	3-19
3.2.3.2 Dynamic Braking	3-21
3.2.3.2.1 Sizing the Braking Resistor	3-21
3.2.3.2.2 Installation of the Braking Resistor	3-22
3.2.3.3 Output Connections.....	3-24
3.2.4 Grounding Connections	3-26
3.2.5 Control Connections.....	3-28
3.2.6 Typical Control Connections	3-32
3.3 SAFETY STOP FUNCTION.....	3-35
3.3.1 Installation	3-38
3.3.2 Operation	3-39
3.3.2.1 Truth Table	3-39
3.3.2.2 State of Inverter, Fault and Alarm Related to Safety Stop Function	3-39
3.3.2.3 STO Status Indication	3-39
3.3.2.4 Periodic Test.....	3-40
3.3.3 Examples of Wiring Diagrams of Inverter Control Signal	3-41
3.3.4 Technical Specifications	3-42
3.3.4.1 Electrical Control Characteristics	3-42
3.3.4.2 Operational Safety Characteristics.....	3-42

3.4 INSTALLATION ACCORDING TO THE EUROPEAN DIRECTIVE OF ELECTROMAGNETIC COMPATIBILITY	3-43
3.4.1 Conformal Installation	3-43
3.4.2 Standard Definitions	3-44
3.4.3 Emission and Immunity Levels.....	3-45
4 HMI	4-1
4.1 INTEGRAL KEYPAD - HMI-CFW11	4-1
5 FIRST TIME POWER-UP AND START-UP	5-1
5.1 PREPARE FOR START-UP	5-1
5.2 START-UP	5-2
5.2.1 Password Setting in P0000	5-3
5.2.2 Oriented Start-Up.....	5-3
5.2.3 Setting Basic Application Parameters.....	5-5
5.3 SETTING DATE AND TIME	5-9
5.4 BLOCKING PARAMETERS MODIFICATION.....	5-10
5.5 HOW TO CONNECT A PC	5-10
5.6 FLASH MEMORY MODULE.....	5-11
6 TROUBLESHOOTING AND MAINTENANCE	6-1
6.1 OPERATION OF THE FAULTS AND ALARMS.....	6-1
6.2 FAULTS, ALARMS, AND POSSIBLE CAUSES	6-2
6.3 SOLUTIONS FOR THE MOST FREQUENT PROBLEMS	6-8
6.4 INFORMATION FOR CONTACTING TECHNICAL SUPPORT	6-8
6.5 PREVENTIVE MAINTENANCE	6-9
6.5.1 Cleaning Instructions	6-10
7 OPTION KITS AND ACCESSORIES	7-1
7.1 OPTION KITS	7-1
7.1.1 RFI Filter.....	7-1
7.1.2 24 Vdc External Control Power Supply	7-2
7.1.3 Nema1 Degree Protection - Frame Sizes A, B and C	7-3
7.1.4 IP21 Degree Protection	7-3
7.1.5 IP55 Degree Protection	7-3
7.1.6 Safety Stop Function	7-3
7.1.7 Switch-Disconnecter on the Inverter Power Supply	7-3
7.2 ACCESSORIES	7-3
8 TECHNICAL SPECIFICATIONS.....	8-1
8.1 POWER DATA.....	8-1
8.2 ELECTRICAL/GENERAL SPECIFICATIONS.....	8-6
8.3 CODES AND STANDARDS.....	8-7
8.4 CERTIFICATIONS.....	8-7
8.5 MECHANICAL DATA.....	8-8
8.6 CONDUIT KIT.....	8-15
8.7 CONDUIT KIT IP21	8-16

1 SAFETY INSTRUCTIONS

This manual provides information for the proper installation and operation of the CFW-11 frequency inverter.

Only trained and qualified personnel should attempt to install, start-up, and troubleshoot this type of equipment.





1.1 SAFETY WARNINGS IN THE MANUAL

The following safety warnings are used in this manual:

 **DANGER!**
Failure to follow the recommended procedures listed in this warning may result in death, serious injury, and equipment damage.

 **DANGER!**
Les procédures concernées par cet avertissement sont destinées à protéger l'utilisateur contre des dangers mortels, des blessures et des détériorations matérielles importantes.

 **ATTENTION!**
Failure to follow the recommended procedures listed in this warning may result in equipment damage.

 **NOTE!**
This warning provides important information for the proper understanding and operation of the equipment.

1.2 SAFETY WARNINGS IN THE PRODUCT

The following symbols are attached to the product and require special attention:

 Indicates a high voltage warning.

 Electrostatic discharge sensitive components.
Do not touch them.

 Indicates that a ground (PE) must be connected securely.

 Indicates that the cable shield must be grounded.

 Indicates a hot surface warning.

1.3 PRELIMINARY RECOMMENDATIONS



DANGER!

Only trained personnel, with proper qualifications, and familiar with the CFW-11 and associated machinery shall plan and implement the installation, starting, operation, and maintenance of this equipment.

The personnel shall follow all the safety instructions described in this manual and/or defined by the local regulations.

Failure to comply with the safety instructions may result in death, serious injury, and equipment damage.



DANGER!

Seulement personnes avec la qualification adéquate et familiarisation avec le CFW-11 et équipements associés doivent planifier ou implémenter l'installation, mise en marche, operation et entretien de cet équipement. Cettes personnes doivent suivre toutes les instructions de sécurités indiquées dans ce manuel, et/ou définies par normes locales. L'inobservance des instructions de sécurité peut résulter en risque de vie et/ou dommages de cet équipement.



NOTE!

For the purpose of this manual, qualified personnel are those trained and able to:

1. Install, ground, power-up, and operate the CFW-11 according to this manual and to the current legal safety procedures.
2. Use the protection equipment according to the established regulations.
3. Provide first aid.



DANGER!

Always disconnect the main power supply before touching any electrical device associated with the inverter.

Several components may remain charged with high voltage and/or in movement (fans), even after the AC power supply has been disconnected or turned off.

Wait at least 10 minutes to guarantee the fully discharge of capacitors.

Always connect the equipment frame to the ground protection (PE).



DANGER!

Débranchez toujours l'alimentation principale avant d'entrer en contact avec un appareil électrique associé au variateur. Plusieurs composants peuvent rester chargés à un potentiel électrique élevé et/ou être en mouvement (ventilateurs), même après la déconnexion ou la coupure de l'alimentation en courant alternatif. Attendez au moins 10 minutes que les condensateurs se déchargent complètement. Raccordez toujours la masse de l'appareil à une terre protectrice (PE).



ATTENTION!

The electronic boards contain components sensitive to electrostatic discharges. Do not touch the components and terminals directly. If needed, touch first the grounded metal frame or wear an adequate ground strap.

**Do not perform a withstand voltage test on any part of the inverter!
If needed, please, consult WEG.**

**NOTE!**

Frequency inverters may cause interference in other electronic devices. Follow the recommendations listed in [Chapter 3 INSTALLATION AND CONNECTION on page 3-1](#), to minimize these effects.

**NOTE!**

Fully read this manual before installing or operating the inverter.

**DANGER!****Crushing Hazard**

In order to ensure safety in load lifting applications, electric and/or mechanical devices must be installed outside the inverter for protection against accidental fall of load.

**DANGER!**

This product was not designed to be used as a safety element. Additional measures must be taken so as to avoid material and personal damages. The product was manufactured under strict quality control, however, if installed in systems where its failure causes risks of material or personal damages, additional external safety devices must ensure a safety condition in case of a product failure, preventing accidents.

**DANGER!****Risque d'écrasement**

Afin d'assurer la sécurité dans les applications de levage de charges, les équipements électriques et/ou mécaniques doivent être installés hors du variateur pour éviter une chute accidentelle des charges.

**DANGER!**

Ce produit n'est pas conçu pour être utilisé comme un élément de sécurité. Des précautions supplémentaires doivent être prises afin d'éviter des dommages matériels ou corporels. Ce produit a été fabriqué sous un contrôle de qualité conséquent, mais s'il est installé sur des systèmes où son dysfonctionnement entraîne des risques de dommages matériels ou corporels, alors des dispositifs de sécurité externes supplémentaires doivent assurer des conditions de sécurité en cas de défaillance du produit, afin d'éviter des accidents.

2 GENERAL INSTRUCTIONS

2.1 ABOUT THE MANUAL

The purpose of this manual is to provide you with the basic information needed to install, start-up in the V/f control mode (scalar), and troubleshoot the most common problems of the CFW-11 frequency inverter series.

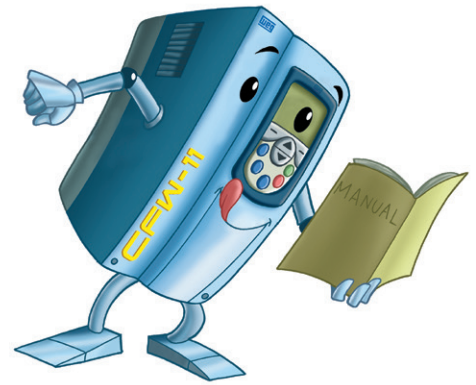

It is also possible to operate the CFW-11 in the following control modes: V V W, Sensorless Vector and Vector with Encoder. For further details on the inverter operation with other control modes, refer to the programming manual.



ATTENTION!

The operation of this equipment requires installation instructions and detailed operation provided in the user's manual, programming manual and manuals/guides for kits and accessories.

The user's manual and the parameters quick reference are supplied in a hard copy together with the inverter.

The user guides are also provided in a hard copy along with the kit/accessories. The other manuals are available at www.weg.net. A printed copy of the files available on WEG's website can be requested at your local WEG dealer.

For information on other functions, accessories, and communication, please refer to the following manuals:

- Programming manual, with a detailed description of the parameters and advanced functions of the CFW-11.
- Incremental encoder interface module manual.
- I/O expansion module manual.
- RS-232/RS-485 serial communication manual.
- CANopen slave communication manual.
- Anybus-CC communication manual.
- DeviceNet communication manual.
- Ethercat communication manual.
- Profibus DP communication manual.
- Symbinet communication manual.
- SoftPLC manual.

2.2 TERMS AND DEFINITIONS

Normal Duty Cycle (ND): inverter duty cycle that defines the maximum continuous operation current ($I_{\text{nom-ND}}$) and the overload current (110 % for 1 minute). The ND cycle is selected by setting P0298 (Application) = 0 (Normal Duty (ND)). This duty cycle shall be used for the operation of motors that are not subjected to high torque loads (with respect to the motor rated torque) during its operation, starting, acceleration, or deceleration.

$I_{\text{nom-ND}}$: inverter rated current for use with the normal duty (ND = Normal Duty).
Overload: $1.1 \times I_{\text{nom-ND}} / 1$ minute.

Heavy Duty Cycle (HD): the duty cycle that defines the steady state current value $I_{\text{nom-HD}}$ and an overload of 150 % during 1 minute. It is selected by programming P0298 (Application) = 1 (Heavy Duty - HD). It must be used for driving motors that are subject in that application to high torques with respect to their rated torque, when operating at constant speed, during start, acceleration or deceleration.

$I_{\text{nom-HD}}$: inverter rated current for use with the heavy duty (HD) cycle.
Overload: $1.5 \times I_{\text{nom-HD}} / 1$ minute.

Rectifier: the input circuit of the inverters that converts the input AC voltage into DC; it is made of thyristors and power diodes.

Pre-charge Circuit: it charges the DC Link capacitors with a limited current, thus avoiding higher current peaks when powering the inverter.

DC Link: inverter intermediate circuit; DC voltage obtained from the rectification of the AC input voltage or from an external power supply; feeds the output inverter bridge with IGBTs.

U, V, W Arms: set of two IGBTs of the inverter output phases U, V, and W.

IGBT: insulated Gate Bipolar Transistor; basic component of the output inverter bridge. The IGBT works as an electronic switch in the saturated (closed switch) and cut-off (open switch) modes.

Braking IGBT: works as a switch to activate the braking resistors; it is controlled by the DC Link voltage level.

Gate Driver: circuit used to turn-on and turn-off the IGBTs.

PWM: Pulse Width Modulation; pulsed voltage that feeds the motor.

Switching Frequency: Frequency of the IGBTs switching in the inverter bridge, normally expressed in kHz.

Heatsink: metal device designed to dissipate the heat generated by the power semiconductors.

PE: Protective Earth.

MOV: Metal Oxide Varistor.

RFI Filter: Radio-Frequency Interference Filter for interference reduction in the radio-frequency range.

PTC: resistor which resistance value in ohms increases proportionally to the temperature increase; used as a temperature sensor in electrical motors.

NTC: resistor which resistance value in ohms decreases proportionally to the temperature increase; used as a temperature sensor in power modules.



HMI: Human-Machine Interface; it is the device that allows the control of the motor, the visualization and the modification of the inverter parameters; it's also known as keypad. The CFW-11 HMI presents keys for commanding the motor, navigation keys and a graphic LCD display.

FLASH Memory: non-volatile memory that can be electronically written and erased.

RAM Memory: Random Access Memory (volatile).

USB: Universal Serial Bus; is a serial bus standard that allows devices to be connected using the "Plug and Play" concept.

General Enable: when activated, this function accelerates the motor via acceleration ramp set in the inverter. When deactivated, this function immediately blocks the PWM pulses. The general enable function may be controlled through a digital input set to this function or via serial communication.

Start/Stop: when enabled in the inverter (Start), this function accelerates the motor via acceleration ramp up to the speed reference. When disabled (Stop), this function decelerates the motor via deceleration ramp up to the complete motor stop; at this point, the PWM pulses are blocked. The Start/Stop function may be controlled through a digital input set for this function or via serial communication. The operator keys  Start, and  Stop of the keypad work in a similar way.

STO: Safe Torque Off; functional safety function available as an option in CFW-11 inverter series. When STO function is enabled the inverter guarantees that there is no movement of the motor shaft. It's also called safety stop function in CFW-11 documentation.

PLC: Programmable Logic Controller.

TBD: value to be defined.

AC: Alternated Current.

DC: Direct Current.

Amp, A: Ampères.

°C: celsius degree.

CFM: Cubic Feet per Minute; unit of flow.

cm: centimeter.

°F: Fahrenheit degree.

General Instructions

ft: foot.

hp: Horse Power = 746 Watts (unit of power, used to indicate the mechanical power of electrical motors).

Hz: hertz.

in: inch.

kg: kilogram = 1000 grams.

kHz: kilohertz = 1000 hertz.

l/s: liters per second.

lb: pound.

m: meter.

mA: milliampère = 0.001 Ampère.

min: minute.

mm: millimeter.

ms: millisecond = 0.001 seconds.

Nm: newton meter; unit of torque.

rms: "root mean square"; effective value.

rpm: revolutions per minute; unit of speed.

s: second.

V: volts.

Ω : ohms.

2.3 ABOUT THE CFW-11

The CFW-11 frequency inverter is a high performance product designed for speed and torque control of three-phase induction motors. The main characteristic of this product is the "Vectrue" technology, which has the following advantages:

- ☑ Scalar control (V/f), VVW ("Voltage Vector WEG") or vector control programmable in the same product.
- ☑ The vector control may be programmed as "sensorless" (which means standard motors without using encoders) or as "vector control" with the use of an encoder.
- ☑ The "sensorless" control allows high torque and fast response, even in very low speeds or at the starting.
- ☑ The "vector with encoder" control allows high speed precision for the whole speed range (even with a standstill motor).
- ☑ "Optimal Braking" function for the vector control: allows the controlled braking of the motor, eliminating the additional braking resistors in some applications.
- ☑ "Self-Tuning" feature for vector control and VVW. It allows the automatic adjustment of the regulators and control parameters from the identification (also automatic) of the motor parameters and load.

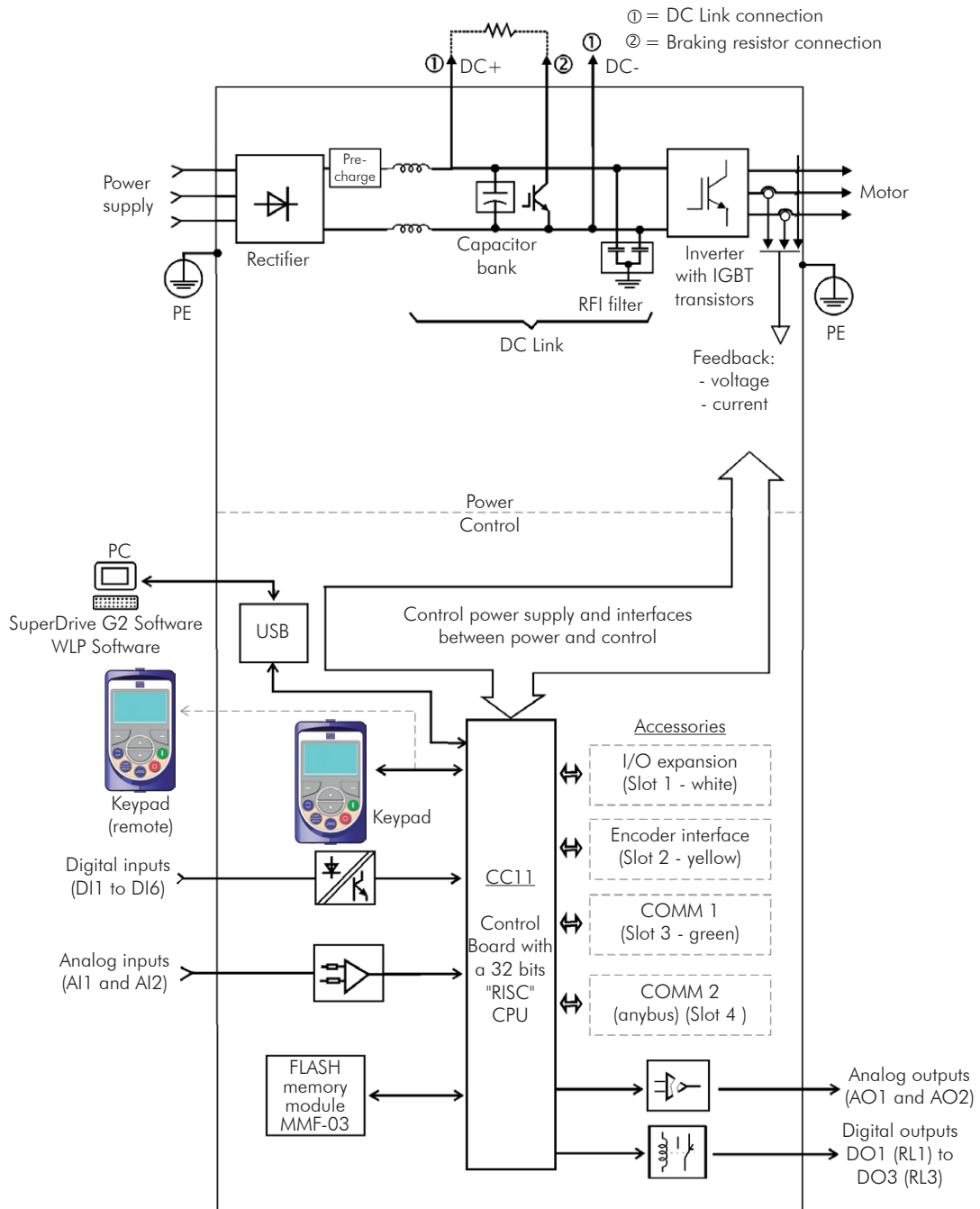

Figure 2.1 - Block diagram for the CFW-11

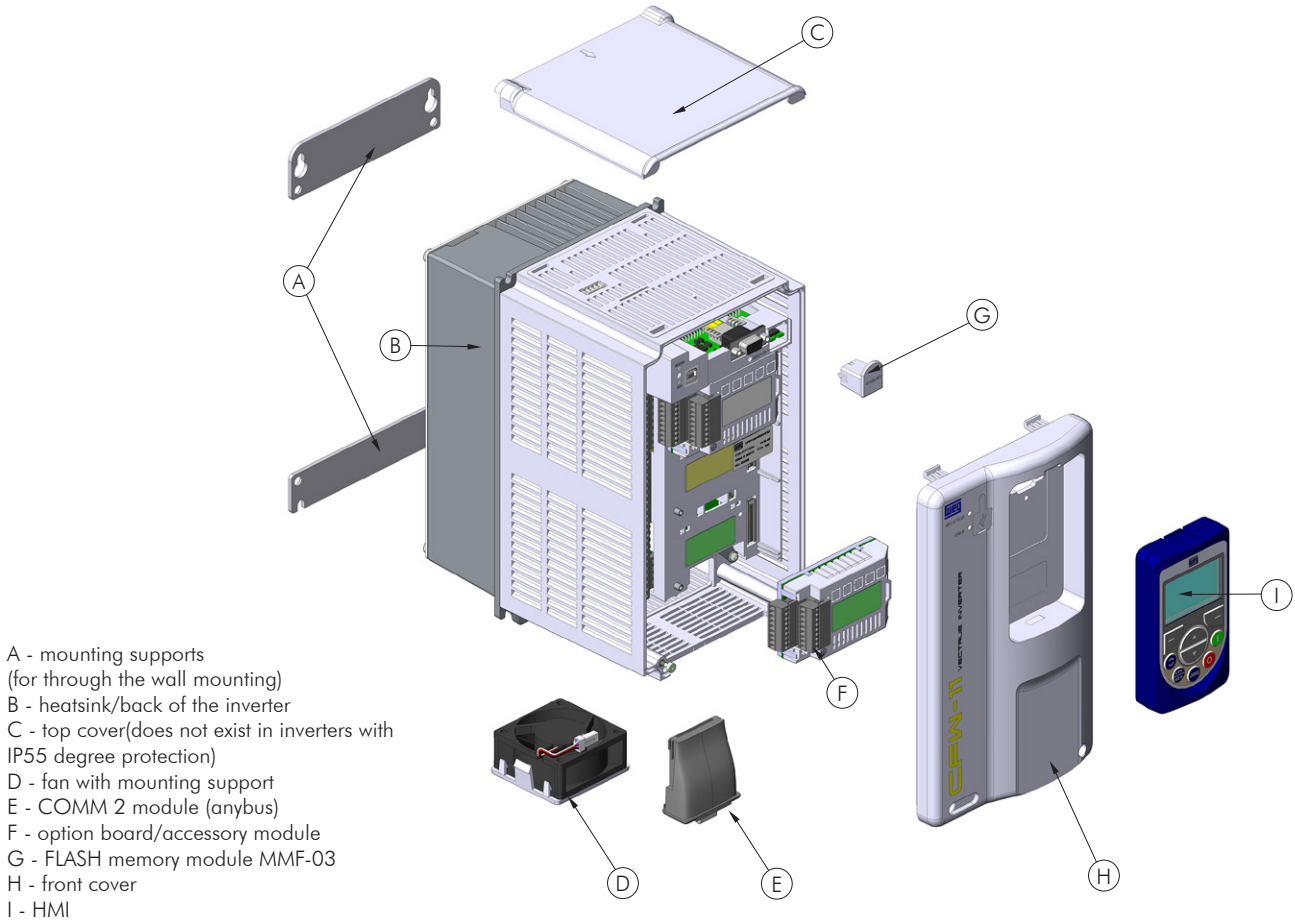

Figure 2.2 - Main components of the CFW-11

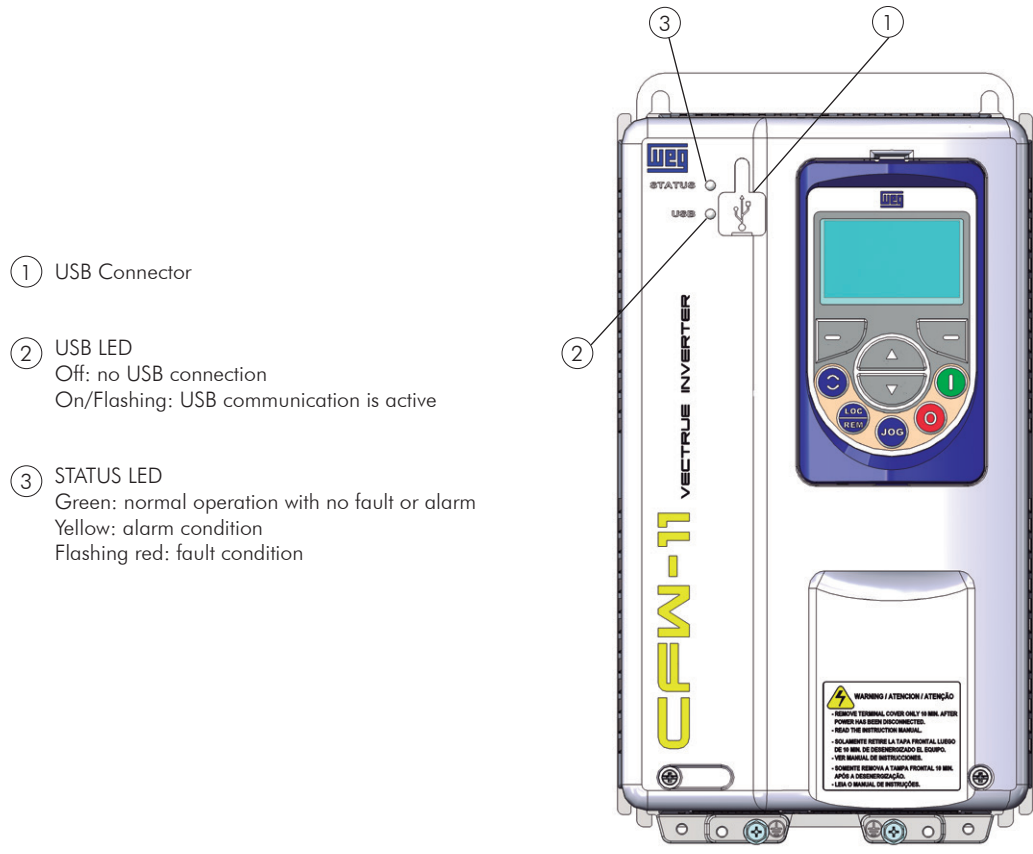

Figure 2.3 - LEDs and USB connector

2.4 IDENTIFICATION LABELS FOR THE CFW-11

There are two nameplates on the CFW-11: one complete nameplate is affixed to the side of the inverter and a simplified one is located under the keypad. The nameplate under the keypad allows the identification of the most important characteristics of the inverter even if they are mounted side-by-side.

CFW-11 model number → MOD.: MSCFW110070T4OFAZ
 WEG part number → MAT.: 12511864 MAX. TA: 50°C(122°F)
 Inverter net weight → PESO/WEIGHT: 31.1kg (68.6lb) 10 L

	LINE LINEA REDE	OUTPUT SALIDA SAIDA
VAC	380-480V 3~	0-REDE 3~
A (ND) 60s/3s	70,5A	70,5A 77,6A / 106A
A (HD) 60s/3s	81A	81A 91,5A / 122A
Hz	50/60Hz	0-300Hz

FABRICADO NO BRASIL
 HECHO EN BRASIL
 MADE IN BRAZIL

UL US LISTED IND. CONT. EQ. 2599
 CE EAC

7 909158 130447

Maximum surrounding air temperature
 Serial number
 Manufacturing date (day-month-year)
 Rated output data (voltage, number of power phases, rated currents for use with Normal Duty (ND) and Heavy Duty (HD) cycles, overload currents for 1 min and 3 s, and frequency range)
 Current specifications for use with the Normal Duty (ND) cycle
 Current specifications for use with the Heavy Duty (HD) cycle

a) Nameplate affixed to the side of the inverter

MSCFW110070T4OFAZ → CFW-11 model number
 12511864 10 L → WEG part number
 SERIAL#: 1234567890 → Serial number
 Manufacturing date (day/month/year)

b) Nameplate located under the keypad

Figure 2.4 - (a) and (b) - Nameplates

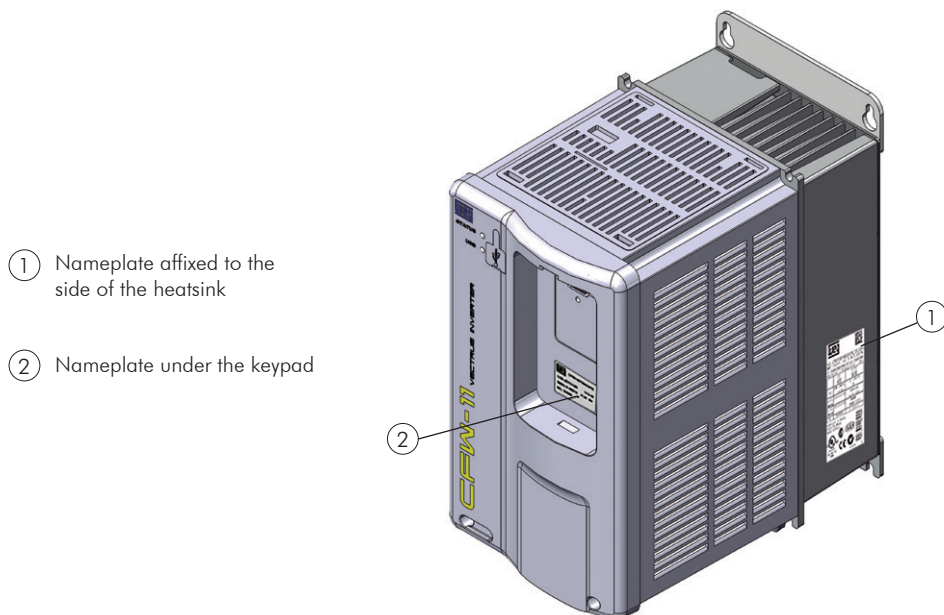

Figure 2.5 - Location of the nameplates

HOW TO CODIFY THE CFW-11 MODEL (SMART CODE)

Example	Inverter Model				Available Option Kits (Can be Installed in the Product From the Factory)											
	BR	CFW-11	0016	T	4	S	--	--	--	--	--	--	Z			
	Market identification (defines the manual language and the factory settings)	WEG CFW-11 frequency inverter series	Rated output current for use with the Normal Duty (ND) cycle	Number of power phases	Power supply voltage	Option kit	Enclosure type	Keypad (HMI)	Braking	Disconnect switch in inverter supply	Disconnect switch in inverter supply ⁽⁶⁾	Safety stop	24 Vdc external power supply for control	Special hardware	Special software	Digit final indicator of encoding
Available options	2 characters			S = single-phase power supply T = three-phase power supply B = single or three-phase power supply	2 = 200...240 V 4 = 380...480 V	S = standard product O = product with option kit	Blank = standard ⁽¹⁾ N1 = Nema1 ⁽⁶⁾ 21 = IP21 ⁽⁷⁾ 55 = IP55	Blank = standard IC = no keypad (blind cover)	Blank = standard ⁽³⁾	Blank = standard class 3 internal RFI filter	Blank = Without disconnecting switch DS = With disconnect switch	Blank = standard Stop function is not available Y = Safety Stop according to ISO 13849-1 category 3 ⁽⁴⁾ ⁽⁵⁾	Blank = standard (not available) W = 24 Vdc external power supply for control	Blank = standard H1 = Special hardware n° 1	Blank = standard S1 = Special software n° 1	

(1) Degree of protection standard frame sizes A, B and C: IP21; frame size D: IP20/Nema1.

(2) Standard HMI CFW-11.

(3) Braking transistor (IGBT) is incorporated in all models of frame sizes A, B, C and D as standard.

(4) Refer to [Section 3.3 SAFETY STOP FUNCTION](#) on page 3-35 for further information.

(5) It is not possible to specify simultaneously optional items Nema1 and safety stop function for inverters of frame size A.

(6) This option is not valid for inverters of frame size D since the standard degree of protection is already Nema 1.

(7) Only applicable for inverters of frame size D.

(8) It is only possible to specify the optional item with switch-disconnector for inverters with degree of protection IP55.

2.5 RECEIVING AND STORAGE

The CFW-11 is packaged and shipped in a cardboard box until the models of frame size C. The bigger frame models are packaged and shipped in a wood crate.

There is an identification label affixed to the outside of the package, identical to the one affixed to the side of the inverter CFW-11.

Follow the instructions below to remove the CFW-11 models above frame size C from the package:

1. Put the shipping container over a flat and stable area with the assistance of another two people.
2. Open the wood crate.
3. Remove all the packing material (the cardboard or styrofoam protection) before removing the inverter.

Verify whether:

1. The CFW-11 nameplate corresponds to the purchased model.
2. Any damage occurred during transportation.

Report any damage immediately to the carrier that delivered your CFW-11 inverter.

If the CFW-11 is not installed soon, store it in a clean and dry location (temperature between -25 °C and 60 °C (-13 °F and 140 °F), with a cover to prevent dust accumulation inside it.



ATTENTION!

When the inverter is stored for a long period, it becomes necessary to perform the capacitor reforming. Refer to the procedure in the [Section 6.5 PREVENTIVE MAINTENANCE on page 6-9](#) in the [Table 6.3 on page 6-9](#).

3 INSTALLATION AND CONNECTION

This chapter provides information on installing and wiring the CFW-11. The instructions and guidelines listed in this manual shall be followed to guarantee personnel and equipment safety, as well as the proper operation of the inverter.



3.1 MECHANICAL INSTALLATION

3.1.1 Installation Environment



NOTE!

The inverters are designed for indoor use only.

Avoid:

- ☑ Direct exposure to sunlight, rain, high humidity, or sea-air.
- ☑ Inflammable or corrosive gases or liquids.
- ☑ Excessive vibration.
- ☑ Dust, metallic particles, and oil mist.

Environment conditions for the operation of the inverter:

- ☑ Temperature of CFW-11 inverters with degree of protection IP2X or Nema1: from -10 °C to 50 °C (104 °F to 122 °F) - rated conditions (measured around the inverter).
- ☑ Temperature of CFW-11 inverter with degree of protection IP55: from -10 °C to 40 °C (50 °F to 104 °F) - rated conditions (measured around the inverter).
- ☑ Current derating according to the ambient temperature:
CFW-11 inverters with degree of protection IP2X or Nema1: from 50 °C to 60 °C (122 °F to 140 °F) - current derating of 2 % for each degree Celsius above 50 °C (122 °F).

CFW-11 inverters with degree of protection IP55: from 40 °C to 50 °C (104 °F to 122 °F) - current derating of 2 % for each degree Celsius above 40 °C (104 °F).

- ☑ Humidity: from 5 % to 95 % non-condensing.
- ☑ Maximum altitude: up to 1000 m (3,300 ft) - rated conditions.
- ☑ From 1000 m to 4000 m (3,300 ft to 13,200 ft) - 1 % of current derating for each 100 m (330 ft) above 1000 m (3,300 ft) altitude. From 2000 m to 4000 m (6,600 ft to 13,200 ft) - maximum voltage (240 V for models 220...240 V and 480 V for models 380...480 V) derating of 1.1 % for each 100 m (330 ft) above 2000 m (6,600 ft).

- ☑ Note that derating specified in items above applies also to dynamic braking IGBT (column effective braking current ($I_{effective}$) of [Table 3.4 on page 3-22](#)).
- ☑ Pollution degree: 2 (according to EN50178 and UL508C) with non-conductive pollution. Condensation shall not originate conduction through the accumulated residues.

3.1.2 Mounting Considerations

Consult the inverter weight at the [Table 8.1 on page 8-2](#).

Mount the inverter in the upright position on a flat and vertical surface.

External dimensions and fixing holes position according to the [Figure 3.1 on page 3-3](#). Refer to [Section 8.6 CONDUIT KIT on page 8-15](#) for further details. For external sizes of frame sizes A, B and C with conduit kit (with optional item Nema1), refer to [Section 8.7 CONDUIT KIT IP21 on page 8-16](#).

First mark the mounting points and drill the mounting holes. Then, position the inverter and firmly tighten the screws in all four corners to secure the inverter.

Minimum mounting clearances requirements for proper cooling air circulation are specified in [Figure 3.2 on page 3-4](#) and [Figure 3.3 on page 3-4](#).

Inverters of frame sizes A, B and C can be arranged side-by-side with no clearance required between them. In this case, the top cover must be removed as shown in [Figure 3.3 on page 3-4](#).

Do not install heat sensitive components right above the inverter.



ATTENTION!

When arranging two or more inverters vertically, respect the minimum clearance A + B ([Figure 3.2 on page 3-4](#)) and provide an air deflecting plate so that the heat rising up from the bottom inverter does not affect the top inverter.



ATTENTION!

Provide conduit for physical separation of the signal, control, and power conductors (refer to [Section 3.2 ELECTRICAL INSTALLATION on page 3-9](#)).

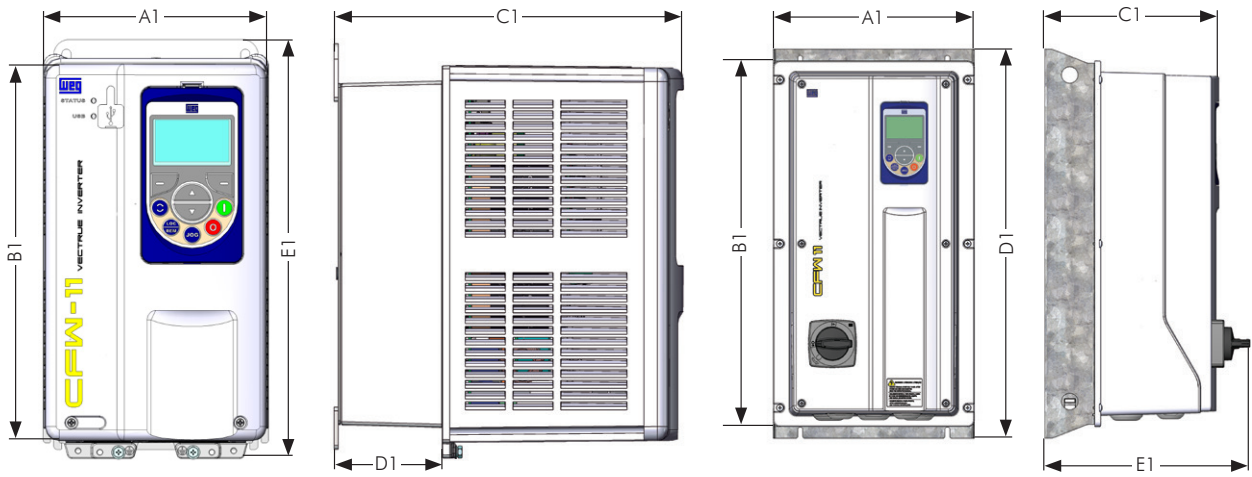

(a.1) Dimensions external in inverters with degree protection IP2X

(a.2) Dimensions external in inverters with degree protection IP55

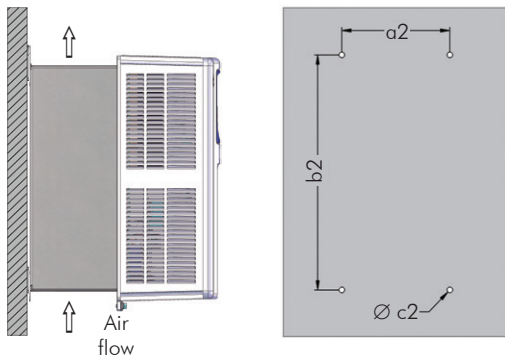

(b) Surface mounting

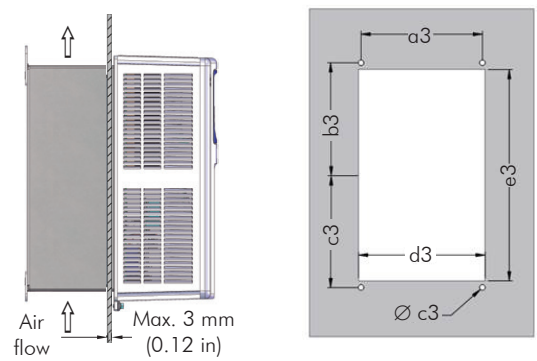

(c) Flange mounting

Model	Protection Degree	A1	B1	C1	D1	E1	a2	b2	c2	a3	b3	c3	d3	e3	f3	Torque (*)
		mm (in)	mm (in)	mm (in)	mm (in)	mm (in)	mm (in)	mm (in)	M	mm (in)	mm (in)	mm (in)	mm (in)	mm (in)	M	N.m (lbf.in)
Frame Size A	IP2X	145 (5.70)	247 (9.72)	227 (8.93)	70 (2.75)	270 (10.62)	115 (4.52)	250 (9.84)	M5	130 (5.11)	120 (4.72)	136 (5.35)	226 (8.89)	M5	5.0 (44.2)	
	IP55	273 (10.74)	497.4 (19.58)	237 (9.33)	68 (2.67)	529 (20.82)	200 (7.87)	505 (19.88)	M8	-	-	-	-	M8	5.0 (44.2)	
Frame Size B	IP2X	190 (7.48)	293 (11.53)	227 (8.94)	71 (2.79)	316 (12.44)	150 (5.90)	300 (11.81)	M5	175 (6.89)	142.5 (5.61)	180 (7.09)	272 (10.71)	M5	5.0 (44.2)	
	IP55	273 (10.74)	497.4 (19.58)	237 (9.33)	68 (2.67)	529 (20.82)	200 (7.87)	505 (19.88)	M8	-	-	-	-	M8	5.0 (44.2)	
Frame Size C	IP2X	220 (8.67)	378 (14.88)	293 (11.52)	136 (5.36)	405 (15.95)	150 (5.91)	375 (14.77)	M6	195 (7.68)	182.5 (7.18)	206 (8.11)	346 (13.62)	M6	8.5 (75.2)	
	IP55	307 (12.08)	588 (23.14)	348 (13.70)	137 (5.39)	670 (26.37)	200 (7.87)	642 (25.75)	M8	-	-	-	-	M8	8.5 (75.2)	
Frame Size D	IP2X	300 (11.81)	504 (19.84)	305 (12.00)	135 (5.32)	550 (21.65)	200 (7.88)	525 (20.67)	M8	275 (10.83)	255 (10.04)	262 (10.31)	287 (11.30)	487 (19.17)	M8	20.0 (177.0)
	IP55	375 (14.76)	707 (27.83)	338.8 (13.33)	129 (5.07)	754 (29.68)	250 (9.84)	725 (28.54)	M8	-	-	-	-	M8	20.0 (177.0)	

Tolerances for dimensions d3 and e3: +1.0 mm (+0.039 in).

Tolerances for remaining dimensions: ±1.0 mm (±0.039 in).

(*) Recommended torque for the inverter mounting (valid for c2 and c3).

Figure 3.1 - (a) to (c) - Mechanical installation details

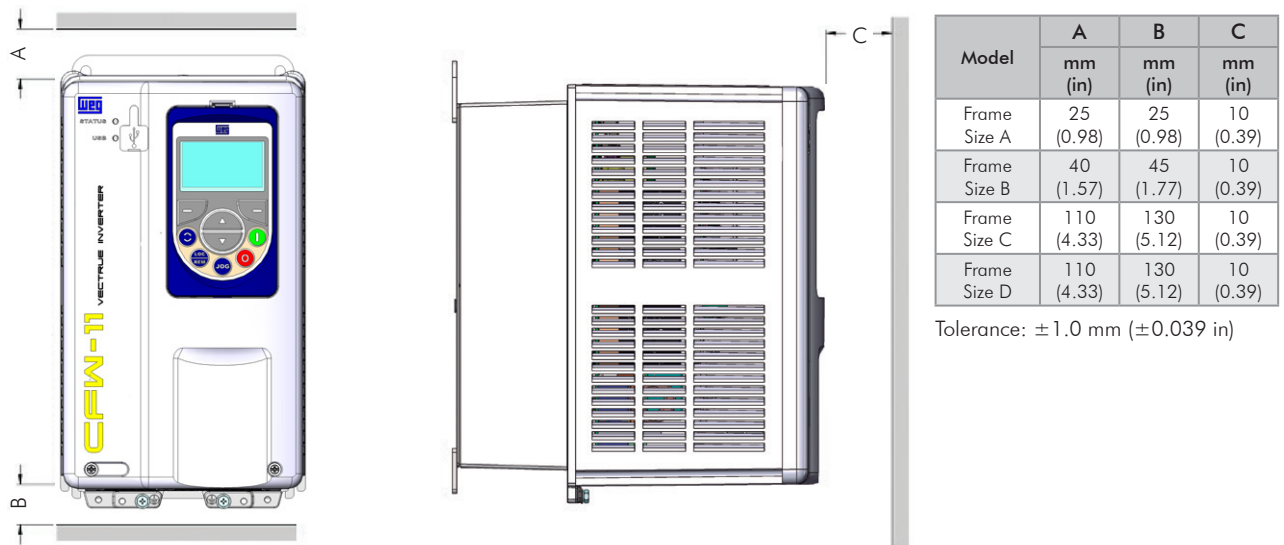
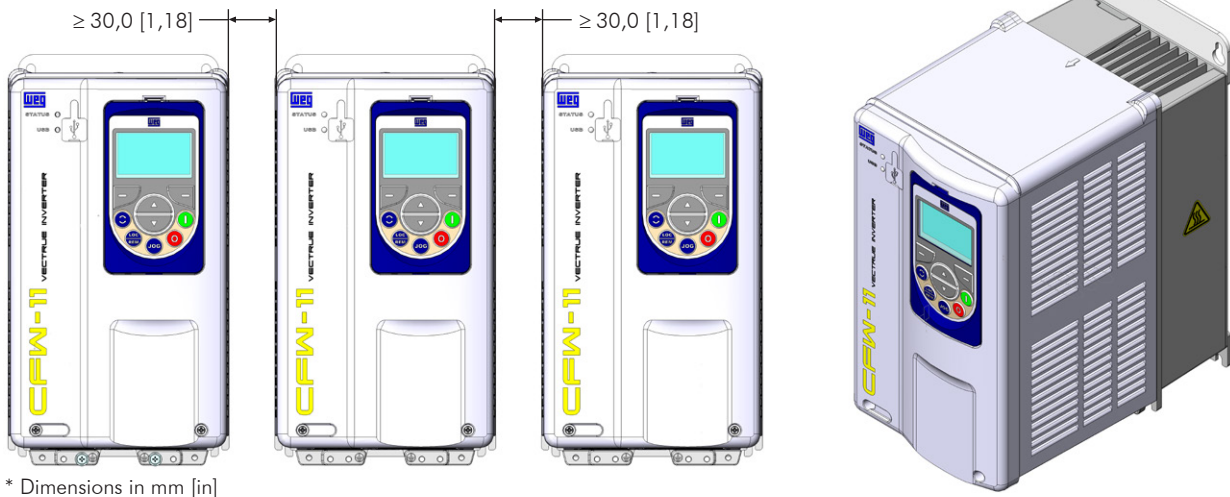
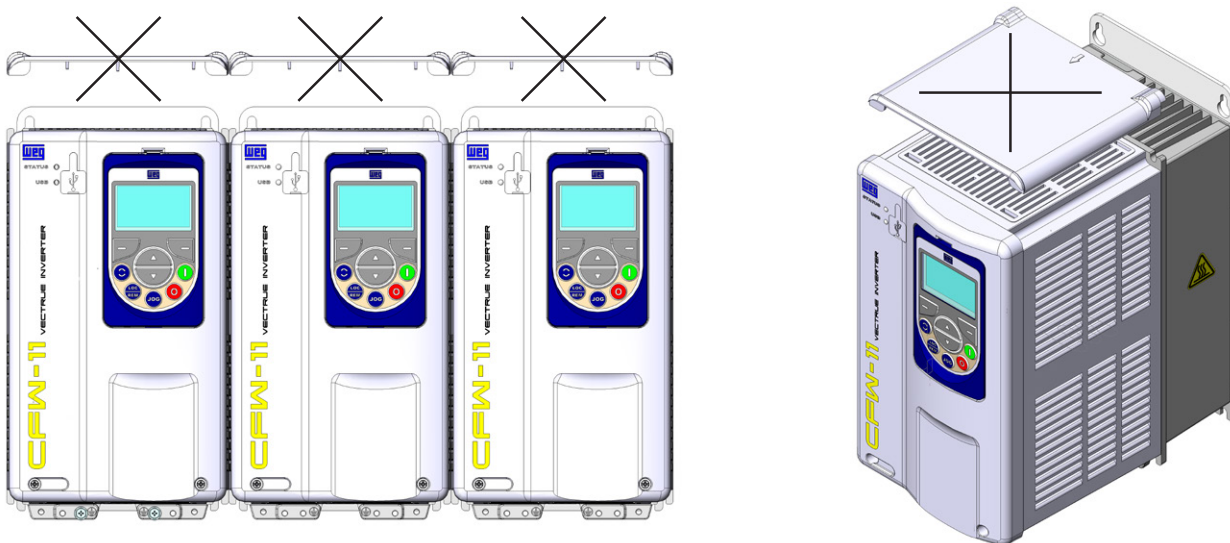

Figure 3.2 - Minimum top, bottom, and front clearance requirements for air circulation



(a) Minimum side clearance requirements



(b) Frame sizes A, B, and C: side-by-side mounting without clearance required between inverters if top cover is removed

Figure 3.3 - (a) and (b) - Minimum side clearance requirements for inverter ventilation

3.1.3 Cabinet Mounting

It is possible to mount the inverters with degree of protection IP2X in two ways: through the wall mounting or flange mounting (the heatsink is mounted outside the cabinet and the cooling air of the power module is kept outside the enclosure). Inverters Nema1 and with degree of protection IP55 can only be surface mounted. The following information can be considered in those cases:

Surface mounting:

- ☑ Provide adequate exhaustion so that the internal cabinet temperature is kept within the allowable operating range of the inverter.
- ☑ The power dissipated by the inverter at its rated condition, as specified in [Table 8.1 on page 8-2](#) "Dissipated power in Watts - through the wall mounting".
- ☑ The cooling air flow requirements, as shown in [Table 3.1 on page 3-5](#).
- ☑ The position and diameter of the mounting holes, according to [Figure 3.1 on page 3-3](#).

Flange mounting:

- ☑ The losses specified in [Table 8.1 on page 8-2](#) "Dissipated power in Watts - flange mounting" will be dissipated inside the cabinet. The remaining losses (power module) will be dissipated through the vents.
- ☑ The mounting supports shall be removed and repositioned as illustrated in [Figure 3.4 on page 3-6](#).
- ☑ The portion of the inverter that is located outside the cabinet is rated IP54. Provide an adequate gasket for the cabinet opening to ensure that the enclosure rating is maintained. Example: silicone gasket.
- ☑ Mounting surface opening dimensions and position/diameter of the mounting holes, as shown in [Figure 3.1 on page 3-3](#).

Table 3.1 - Cooling air flow

Frame Size	CFM	l/s	m ³ /min
A	18	8	0.5
B	42	20	1.2
C	96	45	2.7
D	132	62	3.7

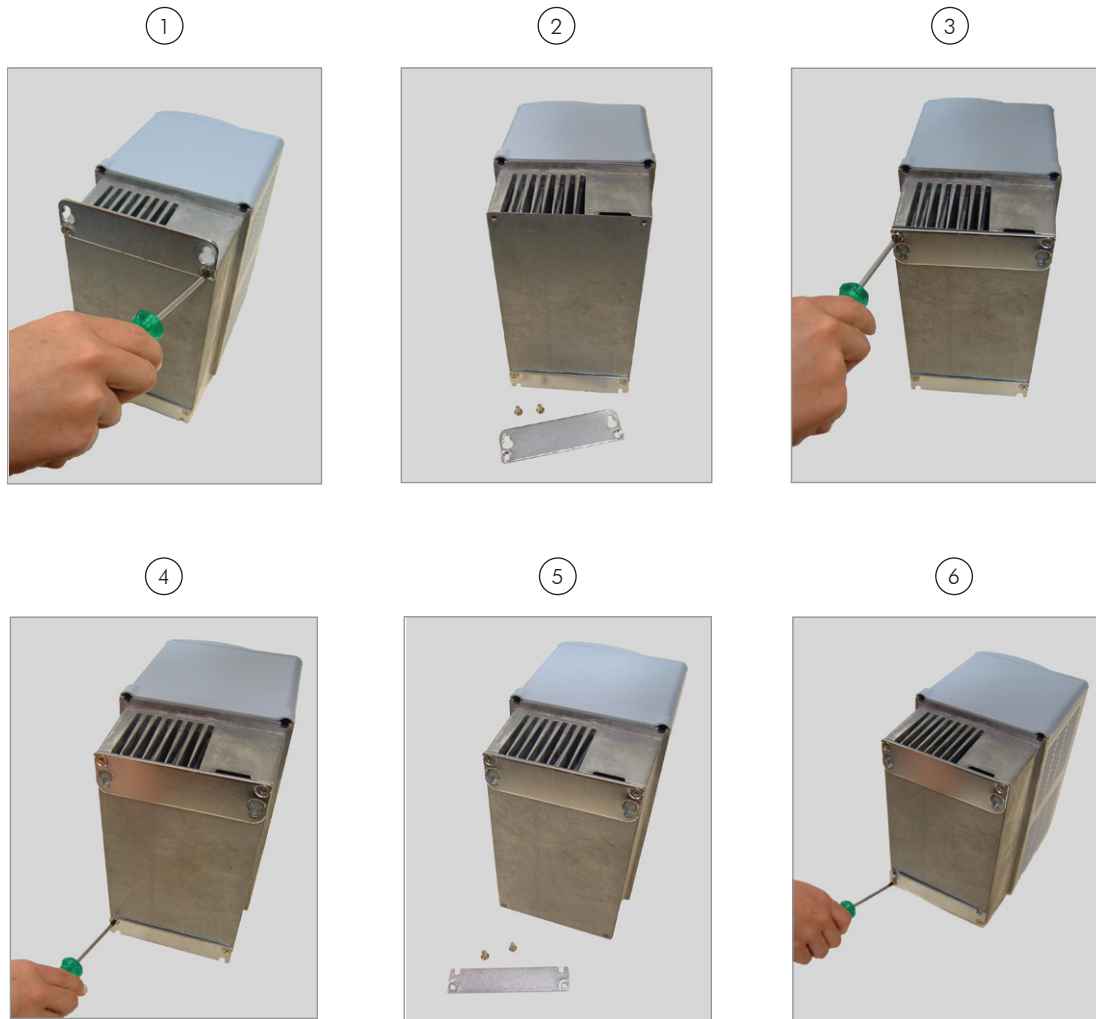
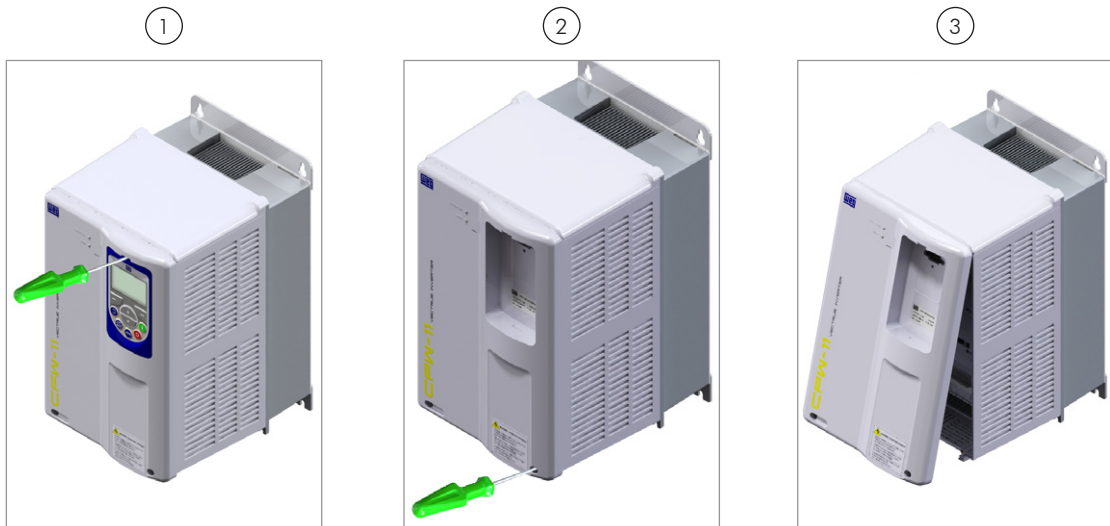

Figure 3.4 - Repositioning the mounting supports

3.1.4 Access to the Control and Power Terminal Strips

On CFW-11 inverters of frame sizes A, B and C with degree of protection IP2X and Nema1 and on all the CFW-11 inverters with degree of protection IP55, it is necessary to remove the HMI and the front cover to access the control and power terminals.

Figure 3.5 on page 3-7 (b) also shows the sequence to tighten the screws to mount the front cover of the inverters with degree of protection IP55.



(a) Frame sizes A, B and C with degree of protection IP2X or Nema1

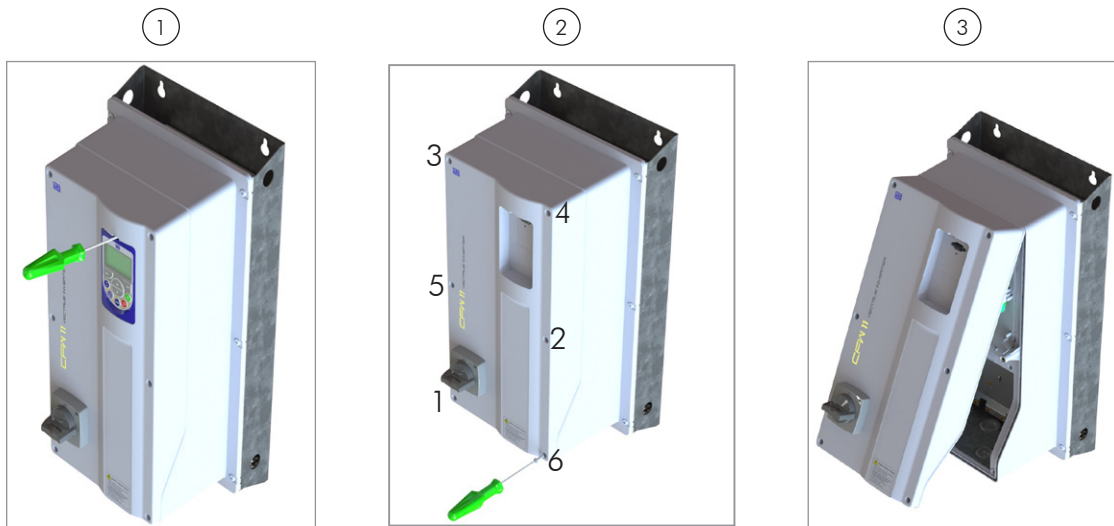

Note: The tightening sequence for mounting the front cover is: 1-2-3-4-5-6. Torque: 2.5 Nm.

(b.1) Frame sizes B and C

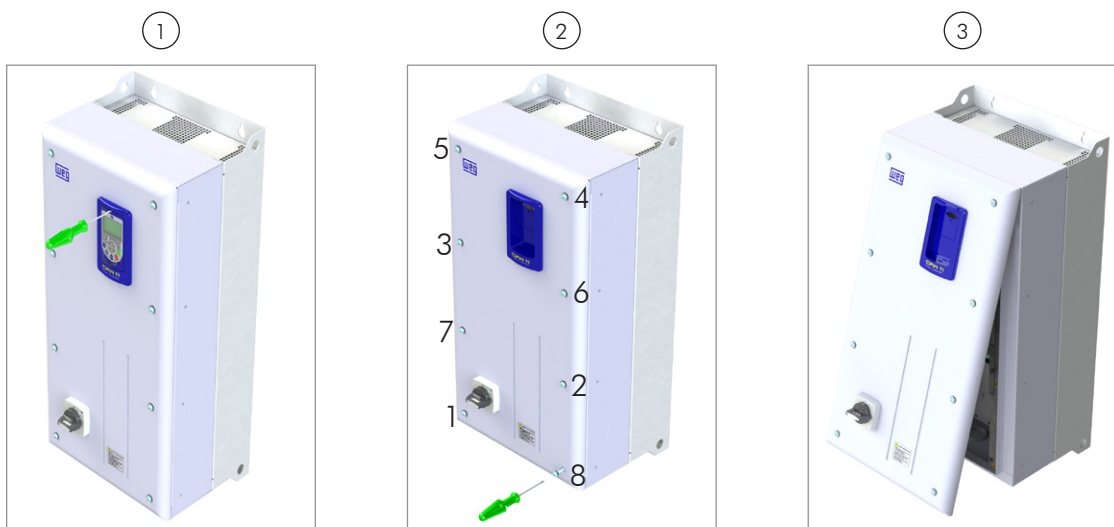

Note: The tightening sequence for mounting the front cover is: 1-2-3-4-5-6. Torque: 2.5 Nm.

(b.2) Frame size D

(b) Models CFW-11 with degree of protection IP55

Figure 3.5 - (a) and (b) - Removal of HMI and front cover

In case of inverters of frame size D with degree of protection IP2X/Nema1, it is necessary to remove the HMI and control rack cover to access the control connectors (see [Figure 3.6 on page 3-8](#)). In order to access the power connectors, remove the lower front cover (see [Figure 3.7 on page 3-8](#)).



Figure 3.6 - HMI and control rack cover removal



Figure 3.7 - Bottom front cover removal

3.1.5 HMI Installation at the Cabinet Door or Command Panel (Remote HMI)

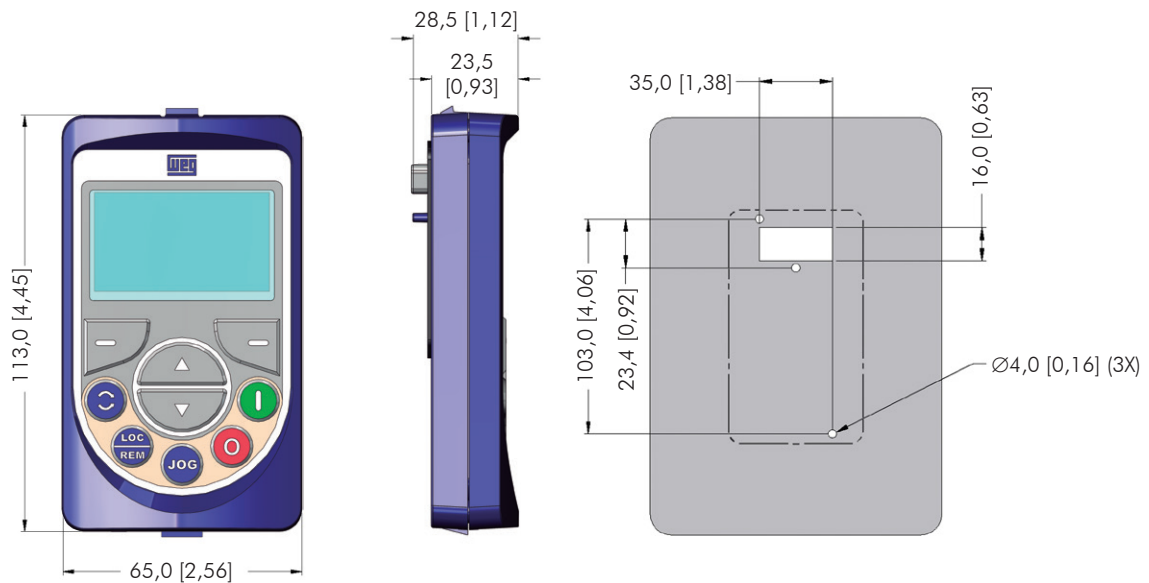

Figure 3.8 - Data for the HMI installation at the cabinet door or command panel - mm [in]

The keypad frame accessory can also be used to fix the HMI, as mentioned in [Table 7.1 on page 7-4](#).

3.2 ELECTRICAL INSTALLATION



DANGER!

The following information is merely a guide for proper installation. Comply with applicable local regulations for electrical installations.



DANGER!

Les informations suivantes constituent uniquement un guide pour une installation correcte. Respectez les réglementations locales en vigueur pour les installations électriques.



DANGER!

Make sure the AC power supply is disconnected before starting the installation.



DANGER!

Vérifiez que l'alimentation secteur CA est débranchée avant de commencer l'installation.



ATTENTION!

The short-circuit protection of the inverter does not provide short-circuit protection for the feeder circuit. The short-circuit protection of the feeder circuit must be provided in accordance with applicable local regulations.

3.2.1 Identification of the Power and Grounding Terminals



NOTE!

Models CFW110006B2 and CFW110007B2 may operate with single-phase power supply without rated output current derating. In this case, the single-phase power supply may be connected to two of any input terminals.

Models CFW110006S2OFA, CFW110007S2OFA, and CFW110010S2 not operate with three-phase voltage. In this case, the single-phase power supply shall be connected to terminals **R/L1** and **S/L2**.

R/L1, S/L2, T/L3: AC power supply.

DC-: this is the negative potential terminal in the DC Link circuit.

BR: braking resistor connection.

DC+: this is the positive potential terminal in the DC Link circuit.

U/T1, V/T2, W/T3: motor connection.

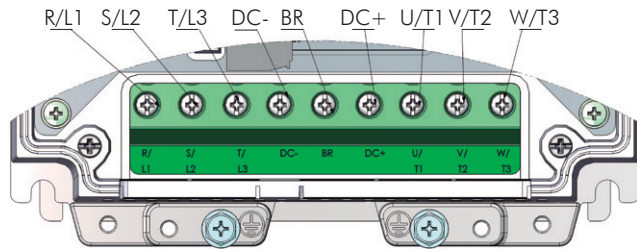

(a) Frame sizes A, B and C

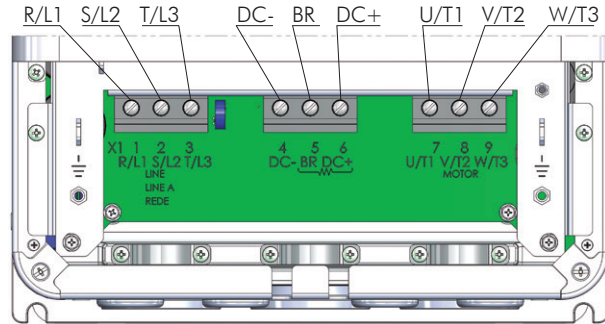

(b) Frame size D

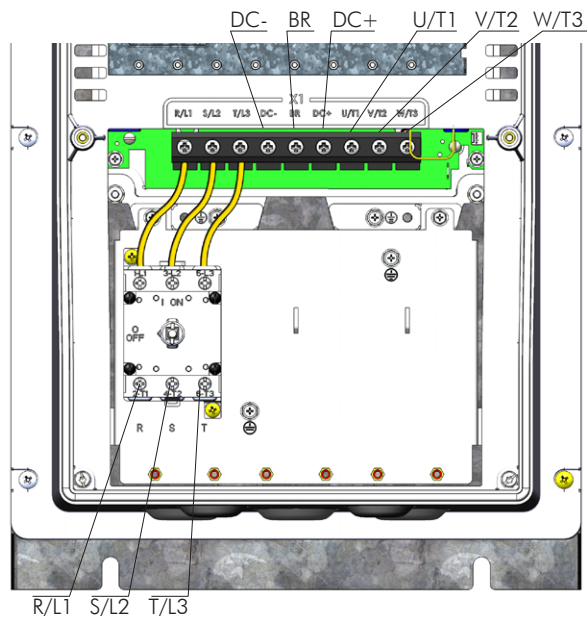

(c) Frame sizes B and C with switch-disconnector (inverters with degree of protection IP55)

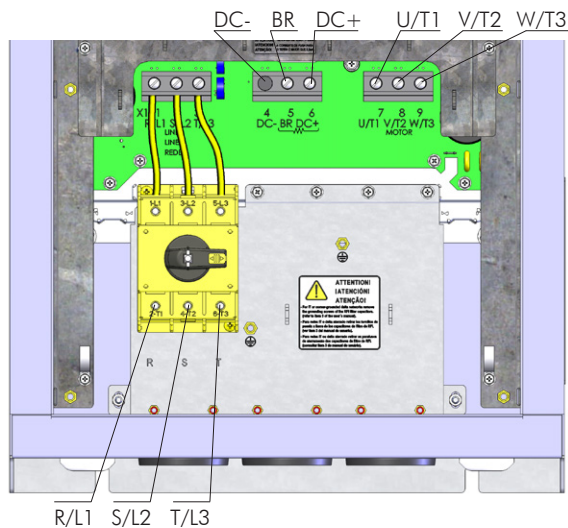

(d) Frame size D with switch-disconnector (inverters with degree of protection IP55)

Figure 3.9 - (a) to (d) - Power terminals

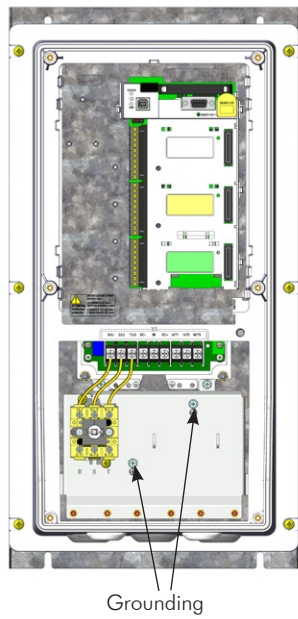
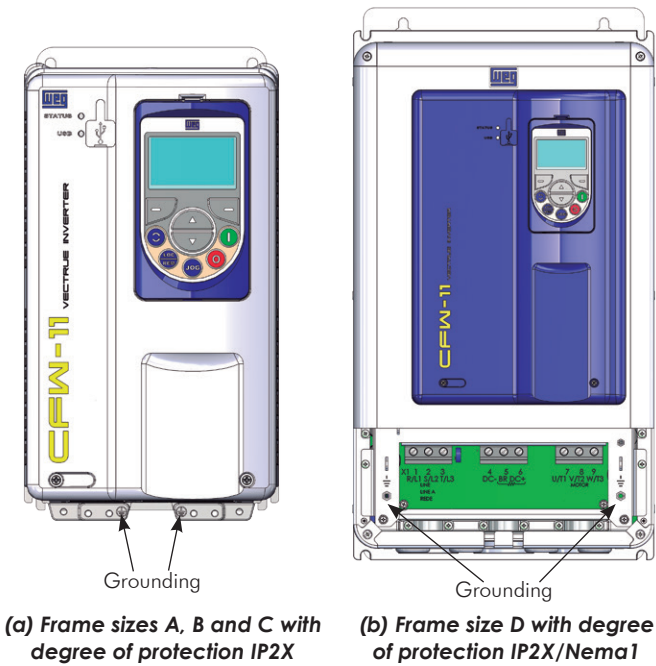

Figure 3.10 - (a) to (c) - Grounding terminals

3.2.2 Power/Grounding Wiring and Fuses

ATTENTION!
 Provide adequate terminals when flexible cables are used for the power and grounding connections.

ATTENTION!
 Sensitive equipment such as PLCs, temperature controllers, and thermal couples shall be kept at a minimum distance of 0.25 m (9.84 in) from the frequency inverter and from the cables that connect the inverter to the motor.

**DANGER!**

Wrong cable connection:

- The inverter will be damaged in case the input power supply is connected to the output terminals (U/T1, V/T2, or W/T3).
- Check all the connections before powering up the inverter.
- In case of replacing an existing inverter by a CFW-11, check if the installation and wiring is according to the instructions listed in this manual.

**DANGER!**

Mauvaise connexion des câbles:

- Le variateur sera endommagé si l'alimentation d'entrée est connectée aux bornes de sortie (U/T1, V/T2 ou W/T3).
- Vérifier toutes les connexions avant de mettre le variateur sous tension.
- En cas de remplacement d'un variateur existant par un CFW-11, vérifier si l'installation et le câblage sont conformes aux instructions figurant dans ce manuel.

**ATTENTION!**

Residual Current Device (RCD):

- When installing an RCD to guard against electrical shock, only devices with a trip current of 300 mA should be used on the supply side of the inverter.
- Depending on the installation (motor cable length, cable type, multimotor configuration, etc.), the RCD protection may be activated. Contact the RCD manufacturer for selecting the most appropriate device to be used with inverters.

**NOTE!**

The wire gauges listed in [Table 3.2 on page 3-14](#) are orientative values. Installation conditions and the maximum permitted voltage drop must be considered for the proper wiring sizing.

Input fuses:

- ☑ The fuse to be used in the input must be of the UF type (Ultra-Fast) with I^2t equal to or smaller than the specified in [Table 3.2 on page 3-14](#) (consider the cold current extinction value (not the melting value) to protect the input rectifier diodes of the inverter and wiring.
- ☑ In order to meet UL requirements, use fuses at the inverter supply with a current not higher than the values of [Table 3.3 on page 3-18](#).
- ☑ Optionally, slow blow fuses can be used at the input they must be sized for 1.2 x the inverter rated input current. In this case, the installation is protected against short-circuit, but not the inverter input rectifier. This may result in major damage to the inverter in the event of an internal component failure.

Table 3.2 - Recommended wire size/fuses - use only copper wire (75 °C (167 °F))

Model	Frame Size	Power Terminals			Wire Size			Fuse In [A]	Fuse I ² t @ 25 °C (77 °F) [A ² s]	Recommended WEG aR Fuse	
		Terminals	Screw (type)	Recommended Torque N.m (lbf.in)	mm ²	AWG	Terminals				
CFW110006B2	A	R/L1 - S/L2 - T/L3	M4 (slotted/ phillips)	1.8 (15.6)	2.5(1φ) (*)/1.5(3φ)	14	Pin terminal	20	420	FNH00-20K-A	
		U/T1 - V/T2 - W/T3 DC+ - DC- (*)			1.5		Ring tongue				
		⊕ (PE)	M4 (phillips)		2.5						
CFW-110006S2OFA	A	R/L1/L - S/L2/N	M4 (slotted/ phillips)	1.8 (15.6)	2.5	14	Pin terminal	20	420	FNH00-20K-A	
		U/T1 - V/T2 - W/T3 DC+ - DC- (*)			1.5		Ring tongue				
		⊕ (PE)	M4 (phillips)		2.5						
CFW110007B2	A	R/L1 - S/L2 - T/L3	M4 (slotted/ phillips)	1.8 (15.6)	2.5(1φ) (*)/1.5(3φ)	12(1φ) (*)/14(3φ)	Pin terminal	20	420	FNH00-20K-A	
		U/T1 - V/T2 - W/T3 DC+ - DC- (*)			1.5	14	Ring tongue				
		⊕ (PE)	M4 (phillips)		2.5	12(1φ) (*)/14(3φ)					
CFW-110007S2OFA	A	R/L1/L, S/L2/N	M4 (slotted/ phillips)	1.8 (15.6)	2.5	12	Pin terminal	20	420	FNH00-20K-A	
		U/T1 - V/T2 - W/T3 DC+ - DC- (*)			1.5	14	Ring tongue				
		⊕ (PE)	M4 (phillips)		2.5	12					
CFW110007T2	A	R/L1 - S/L2 - T/L3 - U/T1 - V/T2 - W/T3 DC+ - DC- (*)	M4 (slotted/ phillips)	1.8 (15.6)	1.5	14	Pin terminal	20	420	FNH00-20K-A	
		⊕ (PE)			M4 (phillips)		2.5				Ring tongue
CFW110010S2	A	R/L1/L - S/L2/N	M4 (slotted/ phillips)	1.8 (15.6)	6	10	Pin terminal	20	1000	FNH00-20K-A	
		U/T1 - V/T2 - W/T3 DC+ - DC- (*)			2.5	14	Ring tongue				
		⊕ (PE)	M4 (phillips)		6	10					
CFW110010T2	A	R/L1 - S/L2 - T/L3 - U/T1 - V/T2 - W/T3 DC+, DC- (*)	M4 (slotted/ phillips)	1.8 (15.6)	2.5	14	Pin terminal	20	420	FNH00-20K-A	
		⊕ (PE)			M4 (phillips)						Ring tongue
CFW110013T2	A	R/L1 - S/L2 - T/L3 - U/T1 - V/T2 - W/T3 DC+ - DC- (*)	M4 (slotted/ phillips)	1.8 (15.6)	2.5	12	Pin terminal	25	420	FNH00-25K-A	
		⊕ (PE)			M4 (phillips)						Ring tongue
CFW110016T2	A	R/L1 - S/L2 - T/L3 - U/T1 - V/T2 - W/T3 DC+ - DC- (*)	M4 (slotted/ phillips)	1.8 (15.6)	4	12	Pin terminal	35	420	FNH00-35K-A	
		⊕ (PE)			M4 (phillips)						Ring tongue
CFW110024T2	A	R/L1 - S/L2 - T/L3 - U/T1 - V/T2 - W/T3 DC+ - DC- (*)	M4 (pozidriv)	1.2 (10.8)	6	10	Pin terminal	40	1000	FNH00-40K-A	
		⊕ (PE)					M4 (phillips)				1.7 (15.0)
CFW110028T2	B	R/L1 - S/L2 - T/L3 - U/T1 - V/T2 - W/T3 DC+ - DC- (*)	M4 (pozidriv)	1.2 (10.8)	6	8	Pin terminal	50	1000	FNH00-50K-A	
		⊕ (PE)					M4 (phillips)				1.7 (15.0)
CFW110033T2	B	R/L1 - S/L2 - T/L3 - U/T1 - V/T2 - W/T3 DC+ - DC- (*)	M4 (pozidriv)	1.2 (10.8)	10	8	Pin terminal	63	1000	FNH00-63K-A	
		⊕ (PE)					M4 (phillips)				1.7 (15.0)

Model	Frame Size	Power Terminals			Wire Size			Fuse In [A]	Fuse I ² t @ 25 °C (77 °F) [A ² s]	Recommended WEG aR Fuse
		Terminals	Screw (type)	Recommended Torque N.m (lbf.in)	mm ²	AWG	Terminals			
CFW110045T2		R/L1 - S/L2 - T/L3 - U/T1 - V/T2 - W/T3 DC+ ⁽²⁾ - DC- ⁽²⁾	M5 (slotted/ phillips)	2.0 (18.0)	10	6	Pin terminal	80	2750	FNH00-80K-A
		⊕ (PE)	M5 (phillips)	3.5 (31.0)			Ring tongue			
CFW110054T2	C	R/L1 - S/L2 - T/L3 - U/T1 - V/T2 - W/T3 DC+ ⁽²⁾ - DC- ⁽²⁾	M5 (slotted/ phillips)	2.0 (18.0)	16	6	Pin terminal	80	2750	FNH00-80K-A
		⊕ (PE)	M5 (phillips)	3.5 (31.0)			Ring tongue			
CFW110070T2		R/L1 - S/L2 - T/L3 - U/T1 - V/T2 - W/T3 DC+ ⁽²⁾ - DC- ⁽²⁾	M5 (slotted/ phillips)	2.0 (18.0)	25	4	Pin terminal	100	2750	FNH00-100K-A
		⊕ (PE)	M5 (phillips)	3.5 (31.0)	16		Ring tongue			
CFW110086T2	D	R/L1 - S/L2 - T/L3 - U/T1 - V/T2 - W/T3 DC+ - DC-	M6 (slotted/ phillips)	2.0 (18.0)	35	2	Pin terminal	125	3150	FNH00-125K-A
		⊕ (PE)	M5 (phillips)	3.5 (31.0)	16	4	Ring tongue			
CFW110105T2		R/L1 - S/L2 - T/L3 - U/T1 - V/T2 - W/T3 DC+ - DC-	M6 (slotted)	2.0 (18.0)	50	1	Pin terminal	125	3150	FNH00-125K-A
		⊕ (PE)	M5 (phillips)	3.5 (31.0)	25	4	Ring tongue			
CFW110003T4		R/L1 - S/L2 - T/L3 - U/T1 - V/T2 - W/T3 DC+ - DC- ⁽¹⁾	M4 (pozidriv)	1.1 (10.0)	1.5	14	Tipo forquilha	20	190	FNH00-20K-A
		⊕ (PE)	M4 (phillips)	1.7 (15.0)			2.5			
CFW110005T4		R/L1 - S/L2 - T/L3 - U/T1 - V/T2 - W/T3 DC+ - DC- ⁽¹⁾	M4 (pozidriv)	1.1 (10.0)	1.5	14	Tipo forquilha	20	190	FNH00-20K-A
		⊕ (PE)	M4 (phillips)	1.7 (15.0)			2.5			
CFW110007T4	A	R/L1 - S/L2 - T/L3 - U/T1 - V/T2 - W/T3 DC+ - DC- ⁽¹⁾	M4 (pozidriv)	1.1 (10.0)	1.5	14	Tipo forquilha	20	190	FNH00-20K-A
		⊕ (PE)	M4 (phillips)	1.7 (15.0)			2.5			
CFW110010T4		R/L1 - S/L2 - T/L3 - U/T1 - V/T2 - W/T3 DC+ - DC- ⁽¹⁾	M4 (pozidriv)	1.1 (10.0)	2.5	14	Tipo forquilha	20	495	FNH00-20K-A
		⊕ (PE)	M4 (phillips)	1.7 (15.0)			Ring tongue			
CFW110013T4		R/L1 - S/L2 - T/L3 - U/T1 - V/T2 - W/T3 DC+ - DC- ⁽¹⁾	M4 (pozidriv)	1.1 (10.0)	2.5	12	Tipo forquilha	25	495	FNH00-25K-A
		⊕ (PE)	M4 (phillips)	1.7 (15.0)			Ring tongue			
CFW110017T4		R/L1 - S/L2 - T/L3 - U/T1 - V/T2 - W/T3 DC+ - DC- ⁽¹⁾	M4 (pozidriv)	1.2 (10.8)	4	10	Pin terminal	35	495	FNH00-35K-A
		⊕ (PE)	M4 (phillips)	1.7 (15.0)			Ring tongue			
CFW110024T4	B	R/L1 - S/L2 - T/L3 - U/T1 - V/T2 - W/T3 DC+ - DC- ⁽¹⁾	M4 (pozidriv)	1.2 (10.8)	6	10	Pin terminal	40	500	FNH00-40K-A
		⊕ (PE)	M4 (phillips)	1.7 (15.0)			Ring tongue			
CFW110031T4		R/L1 - S/L2 - T/L3 - U/T1 - V/T2 - W/T3 DC+ - DC- ⁽¹⁾	M4 (pozidriv)	1.2 (10.8)	10	8	Pin terminal	50	1250	FNH00-50K-A
		⊕ (PE)	M4 (phillips)	1.7 (15.0)			Ring tongue			

Model	Frame Size	Power Terminals			Wire Size			Fuse In [A]	Fuse I ^{2t} @ 25 °C (77 °F) [A ² s]	Recommended WEG aR Fuse
		Terminals	Screw (type)	Recommended Torque N.m (lbf.in)	mm ²	AWG	Terminals			
CFW110038T4	C	R/L1 - S/L2 - T/L3 - U/T1 - V/T2 - W/T3 DC+ ⁽²⁾ - DC- ⁽²⁾	M5 (slotted/ phillips)	2.0 (18.0)	10	8	Pin terminal	63	1250	FNH00-63K-A
		⊕ (PE)	M5 (phillips)	3.5 (31.0)			Ring tongue			
CFW110045T4	C	R/L1 - S/L2 - T/L3 - U/T1 - V/T2 - W/T3 DC+ ⁽²⁾ - DC- ⁽²⁾	M5 (slotted/ phillips)	2.0 (18.0)	10	6	Pin terminal	80	2100	FNH00-80K-A
		⊕ (PE)	M5 (phillips)	3.5 (31.0)			Ring tongue			
CFW110058T4	C	R/L1 - S/L2 - T/L3 - U/T1 - V/T2 - W/T3 DC+ ⁽²⁾ - DC- ⁽²⁾	M5 (slotted/ phillips)	2.0 (18.0)	16	4	Pin terminal	100	2100	FNH00-100K-A
		⊕ (PE)	M5 (phillips)	3.5 (31.0)			Ring tongue			
CFW110070T4	D	R/L1 - S/L2 - T/L3 - U/T1 - V/T2 - W/T3 DC+ - DC-	M5 (slotted/ phillips)	2.9 (24.0)	25	3	Pin terminal	100	2100	FNH00-100K-A
		⊕ (PE)	M5 (phillips)	3.5 (31.0)			Ring tongue			
CFW110088T4	D	R/L1 - S/L2 - T/L3 - U/T1 - V/T2 - W/T3 DC+ - DC-	M5 (slotted/ phillips)	2.9 (24.0)	35	2	Pin terminal	125	3150	FNH00-125K-A
		⊕ (PE)	M5 (phillips)	3.5 (31.0)			Ring tongue			

1φ: (*) Wire size for single-phase power supply.

(1) There is a plastic cover in front of the DC- terminal at the frame sizes A and B inverters. It is necessary to break off that cover in order to get access to this terminal.

(2) There are plastic covers in front of the DC-, DC+ and BR terminals at the frame size C. It is necessary to break off those covers in order to get access to these terminals.

3.2.3 Power Connections

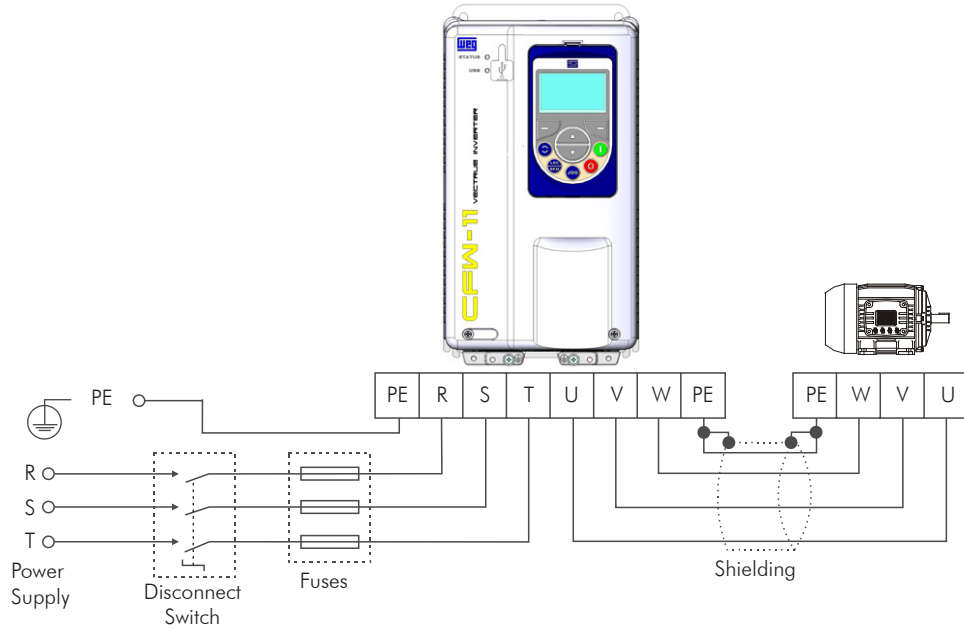

Figure 3.11 - Power and grounding connections

3.2.3.1 Input Connections

**DANGER!**

Provide a disconnect device for the input power supply of the inverter.
This device shall disconnect the input power supply for the inverter when needed (for instance, during servicing).

**DANGER!**

Montez un dispositif de coupure sur l'alimentation du variateur. Ce composant déconnecte l'alimentation du variateur si cela est nécessaire (ex. pendant l'entretien et la maintenance).

**ATTENTION!**

A contactor or another device that frequently disconnects and reapplies the AC supply to the inverter, in order to start and stop the motor, may cause damage to the inverter power section. The drive is designed to use control signals for starting and stopping the motor. If used for that purpose, the input device must not exceed one operation per minute; otherwise, the inverter may be damaged.

**ATTENTION!**

The power supply that feeds the inverter shall have a grounded neutral. In case of IT networks, follow the instructions described in [Item 3.2.3.1.1 Power Supply Capacity on page 3-18](#).

**NOTE!**

The input power supply voltage shall be compatible with the inverter rated voltage.

**NOTE!**

Power factor correction capacitors are not needed at the inverter input (R, S, T) and shall not be installed at the output of the inverter (U, V, W).

3.2.3.1.1 Power Supply Capacity

- ☑ Suitable for circuits with capacity to deliver no more than:
 - 100 kA symmetric at 240 V or 480 V when the inverter is protected by fuses;
 - 65 kA symmetric at 240 V or 480 V when the inverter is protected by reverse-type circuit breakers.
- For compliance with UL standard and specification of current of fuses and circuit breaker see [Table 3.3 on page 3-18](#).

Table 3.3 - Fuses and circuit breaker specifications according to UL standard

Model	Inverter Protection With Class J Fuses (*)		Inverter Protection With Circuit Breaker		
	Rated Current of Fuse	Maximum Power Supply Short-Circuit Current	Rated Current of Circuit Breaker	Minimum Cabinet Dimensions (Depth X Height X Width)	Maximum Power Supply Short-Circuit Current
CFW11 0006 B 2	20 A	100 kA	15 A	203 x 457 x 508 mm (8 x 18 x 20 in)	65 kA
CFW11 0006 S 2 O FA	20 A		15 A		
CFW11 0007 T 2	20 A		15 A		
CFW11 0007 B 2	20 A		15 A		
CFW11 0007 S 2 O FA	20 A		15 A		
CFW11 0010 S 2	25 A		15 A		
CFW11 0010 T 2	25 A		15 A		
CFW11 0013 T 2	25 A		15 A		
CFW11 0016 T 2	25 A		20 A		
CFW11 0024 T 2	35 A		30 A		
CFW11 0028 T 2	35 A		30 A		
CFW11 0033 T 2	35 A		40 A		
CFW11 0045 T 2	60 A		50 A		
CFW11 0054 T 2	60 A		60 A		
CFW11 0070 T 2	100 A (*)		80 A		
CFW11 0086 T 2	100 A		100 A		
CFW11 0105 T 2	125 (*)		125 A		
CFW11 0003 T 4	20 A		15 A	203 x 457 x 508 mm (8 x 18 x 20 in)	
CFW11 0005 T 4	20 A		15 A		
CFW11 0007 T 4	20 A		15 A		
CFW11 0010 T 4	20 A		15 A		
CFW11 0013 T 4	25 A		20 A		
CFW11 0017 T 4	35 A		20 A		
CFW11 0024 T 4	35 A		30 A		
CFW11 0031 T 4	35 A		40 A		
CFW11 0038 T 4	50 A		40 A		
CFW11 0045 T 4	60 A		50 A		
CFW11 0058 T 4	60 A		60 A		
CFW11 0070 T 4	80 A		80 A		
CFW11 0088 T 4	100 A		100 A		
				203 x 762 x 610 mm (8 x 30 x 24 in)	

(*) In the indicated models use semiconductor fuses instead of class J fuses.

3.2.3.1.2 IT Networks



ATTENTION!

Do not use inverters with internal RFI filters in IT networks (neutral is not grounded or grounding provided by a high ohm value resistor) or in grounded delta networks ("delta corner earth"), because these type of networks damage the inverter filter capacitors.

The CFW-11 inverter series, except the models with internal RFI filters – CFW11XXXXXOFA, can be normally used in IT networks. If the available model is equipped with an internal filter, remove the two grounding screws from the filter capacitors as presented in [Figure 3.12 on page 3-20](#). Remove the keypad and the front cover to have access to these screws in frame sizes A, B, and C. For frame size D, the bottom front cover shall be removed as well.

Consider the following items for the use of protection devices on the supply side of the inverter such as residual current devices or isolation monitors:

- The detection of a phase-to-ground short-circuit or an insulation fault shall be processed by the user, i.e., the user shall decide whether to indicate the fault and/or block the inverter operation.
- Contact the RCD manufacturer for selecting the most appropriate device to be used with inverters in order to avoid nuisance tripping due to the high frequency leakage currents that flow through the leakage capacitances of the inverter, cable, and motor system to the ground.

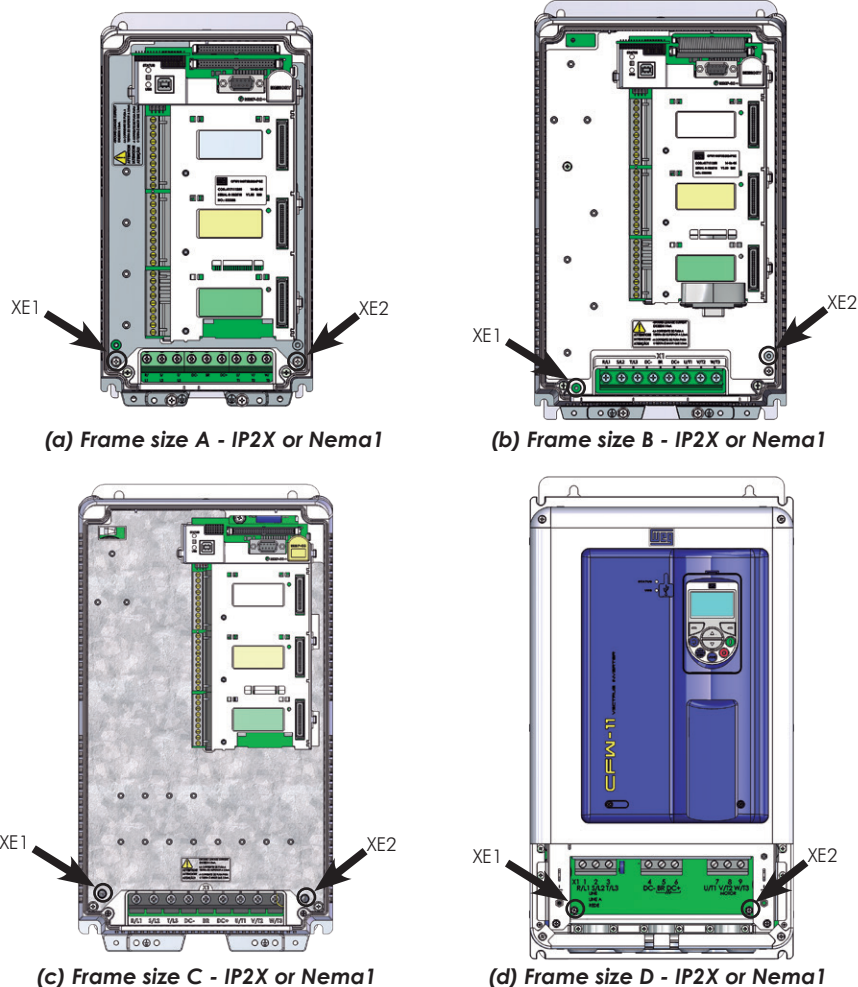

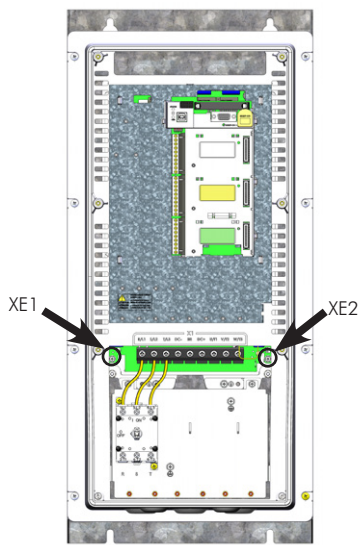

(e) Models up to 16T2 and 13T4 with degree of protection IP55 (frame size B) all of frame size C with degree of protection IP55

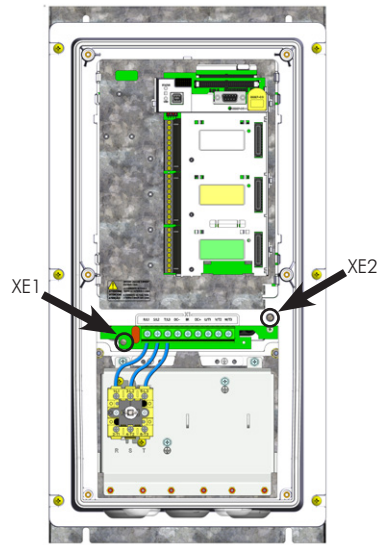

(f) Models 24T2, 28T2, 33T2, 17T4, 24T4 and 31T4 with degree of protection IP55 (frame size B)

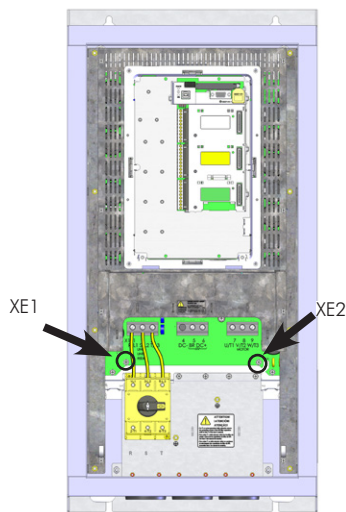

(g) Frame size D IP55

Figure 3.12 - (a) to (g) - Grounding screws of the filter capacitors - valid for models with internal RFI filters

3.2.3.2 Dynamic Braking

**NOTE!**

All frame sizes A, B, C and D models do have internal braking IGBT.

The braking torque that can be obtained from the frequency inverter without braking resistors varies from 10 % to 35 % of the motor rated torque.

Braking resistors shall be used to obtain higher braking torques. In this case, the energy regenerated in excess is dissipated in a resistor mounted externally to the inverter.

This type of braking is used in cases where short deceleration times are desired or when high inertia loads are driven.

The "Optimal Braking" feature may be used with the vector control mode, which eliminates in most cases the need of an external braking resistor.

**NOTE!**

Set P0151 and P0185 to their maximum values (400 V or 800 V) when using dynamic braking.

3.2.3.2.1 Sizing the Braking Resistor

The following application data shall be considered for the adequate sizing of the braking resistor:

- Desired deceleration time.
- Load inertia.
- Braking duty cycle.

In any case, the effective current value and the maximum braking current value presented in [Table 3.4 on page 3-22](#) shall be respected.

The maximum braking current defines the minimum braking resistor value in ohms.

The DC Link voltage level for the activation of the dynamic braking function is defined by parameter P0153 (dynamic braking level).

The power of the braking resistor is a function of the deceleration time, the load inertia, and the load torque.

For most applications, a braking resistor with the value in ohms indicated in [Table 3.4 on page 3-22](#) and the power of 20 % of the rated driven motor power. Use WIRE type resistors in a ceramic support with adequate insulation voltage and capable of withstanding high instantaneous power with respect to rated power. For critical applications with very short deceleration times and high inertia loads (ex.: centrifuges) or short duration cycles, consult WEG for the adequate sizing of the braking resistor.

Table 3.4 - Dynamic braking specifications

Inverter Model	Maximum Braking Current (I_{max}) [A]	Maximum Braking Power (Peak Value) (P_{max}) ⁽²⁾ [kW]	Effective Braking Current ($I_{effective}$) ⁽¹⁾ [A]	Dissipated Power (Mean Value) in the Braking Resistor (P_R) ⁽²⁾ [kW]	Recommended Resistor [Ω]	Power Wire Size (Terminals DC+ and BR) ⁽³⁾ [mm ² (AWG)]
CFW11 0006 B2	7.8	3.1	5.20	1.4	51	1.5 (16)
CFW11 0006 S2 O FA	7.8	3.1	5.20	1.4	51	1.5 (16)
CFW11 0007 B2	12.1	4.8	6.96	1.6	33	1.5 (16)
CFW11 0007 S2 O FA	12.1	4.8	6.96	1.6	33	1.5 (16)
CFW11 0007 T2	7.8	3.1	5.20	1.4	51	1.5 (16)
CFW11 0010 S2	14.8	5.9	10.83	3.2	27	2.5 (14)
CFW11 0010 T2	12.1	4.8	6.96	1.6	33	1.5 (16)
CFW11 0013 T2	14.8	5.9	8.54	2.0	27	2.5 (14)
CFW11 0016 T2	20.0	8.0	14.44	4.2	20	4 (12)
CFW11 0024 T2	26.7	10.7	19.15	5.50	15	6 (10)
CFW11 0028 T2	30.8	12.3	18.21	4.3	13	6 (10)
CFW11 0033 T2	30.8	12.3	16.71	3.6	13	6 (10)
CFW11 0045 T2	44.0	17.6	33.29	10.1	9.1	10 (8)
CFW11 0054 T2	48.8	19.5	32.17	8.49	8.2	10 (8)
CFW11 0070 T2	48.8	19.5	26.13	5.60	8.2	6 (8)
CFW11 0086 T2	133	53.3	90.67	24.7	3.0	35 (2)
CFW11 0105 T2	133	53.3	90.87	24.8	3.0	35 (2)
CFW11 0003 T4	8.0	6.4	3.54	1.3	100	1.5 (16)
CFW11 0005 T4	8.0	6.4	5.20	2.7	100	1.5 (16)
CFW11 0007 T4	8.0	6.4	5.20	2.7	100	1.5 (16)
CFW11 0010 T4	14.3	11.4	8.57	4.1	56	2.5 (14)
CFW11 0013 T4	14.3	11.4	10.40	6.1	56	2.5 (14)
CFW11 0017 T4	14.3	11.4	12.58	8.9	56	2.5 (12)
CFW11 0024 T4	36.4	29.1	16.59	6.1	22	4 (10)
CFW11 0031 T4	40.0	32.0	20.49	8.4	20	6 (10)
CFW11 0038 T4	40.0	32.0	26.06	13.6	20	6 (8)
CFW11 0045 T4	66.7	53.3	40.00	19.2	12	10 (8)
CFW11 0058 T4	66.7	53.3	31.71	12.1	12	10 (8)
CFW11 0070 T4	66.7	53.3	42.87	22.1	12	10 (6)
CFW11 0088 T4	129	103	63.08	24.7	6.2	25 (4)

(1) The effective braking current presented is just an indicative value, because it depends on the braking duty cycle. The effective braking current can be obtained from the equation below, where t_{br} is given in minutes and corresponds to the sum of all braking times during the most severe cycle of 5 (five) minutes.

$$I_{effective} = I_{max} \times \sqrt{\frac{t_{br}}{5}}$$

(2) The P_{max} and P_R values (maximum and mean power of the braking resistor respectively) presented are valid for the recommended resistors and for the effective braking currents presented in Table 3.4 on page 3-22. The resistor power shall be changed according to the braking duty cycle.

(3) For specifications on the recommended terminal type (screw and tightening torque) for the connection of the braking resistor (terminals DC+ and BR), refer to the DC+ terminal specification at the Table 3.2 on page 3-14. There are plastic covers in front of the DC-, DC+ and BR terminals at the frame size C. It is necessary to break off those covers in order to get access to these terminals.

3.2.3.2.2 Installation of the Braking Resistor

Install the braking resistor between the power terminals DC+ and BR.

Use twisted cable for the connection. Separate these cables from the signal and control cables. Size the cables according to the application, respecting the maximum and effective currents.

If the braking resistor is installed inside the inverter cabinet, consider its additional dissipated energy when sizing the cabinet ventilation.

Set parameter P0154 with the resistor value in ohms and parameter P0155 with the maximum resistor power in kW.



DANGER!

The inverter has an adjustable thermal protection for the braking resistor. The braking resistor and the braking transistor may damage if parameters P0153, P0154, and P0155 are not properly set or if the input voltage surpasses the maximum permitted value.



DANGER!

Le variateur possède une protection thermique réglable pour la résistance de freinage. La résistance de freinage et le transistor de freinage peuvent être endommagés si les paramètres P0153, P0154 et P0155 ne sont pas correctement définis ou si la tension d'entrée dépasse la valeur maximale autorisée.

The thermal protection offered by the inverter, when properly set, allows the protection of the resistor in case of overload; however, this protection is not guaranteed in case of braking circuitry failure. In order to avoid any damage to the resistor or risk of fire, install a thermal relay in series with the resistor and/or a thermostat in contact with the resistor body to disconnect the input power supply of the inverter, as presented in [Figure 3.13](#) on page 3-23.

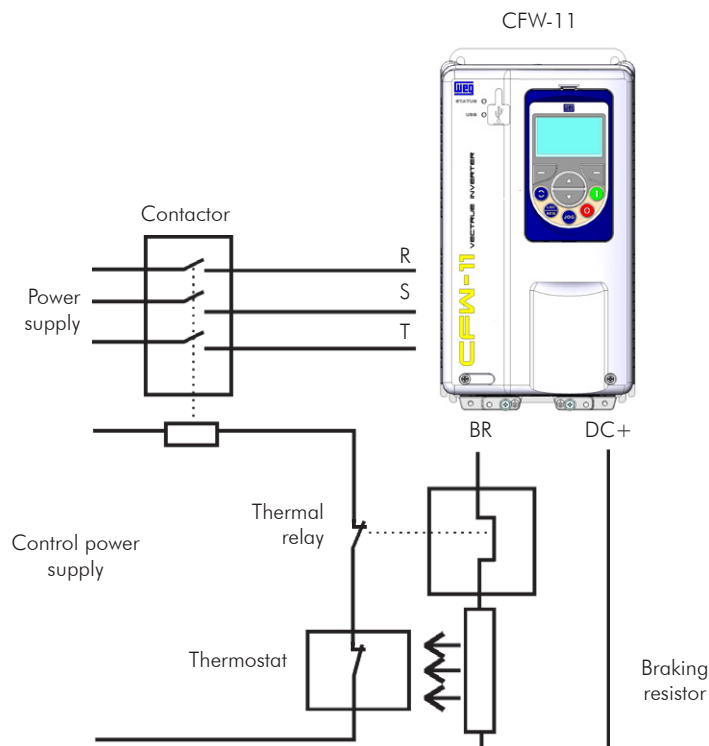

Figure 3.13 - Braking resistor connection



NOTE!

DC current flows through the thermal relay bimetal strip during braking.

3.2.3.3 Output Connections



ATTENTION!

The inverter has an electronic motor overload protection that shall be adjusted according to the driven motor. When several motors are connected to the same inverter, install individual overload relays for each motor.



ATTENTION!

The motor overload protection available in the CFW-11 is in accordance with the IEC60947-4-2 and UL508C standards, note the following information:

- ☑ Trip current equal to 1.25 times the motor rated current (P0401) adjusted in the oriented start-up menu.
- ☑ The maximum value for P0398 (Motor service factor) is 1.15.
- ☑ Parameters P0156, P0157 and P0158 (Overload current at 100 %, 50 % and 5 % of the rated speed, respectively) are automatically adjusted when parameters P0401 (Motor Rated Current) and/or P0406 (Motor Ventilation) are adjusted in the oriented start-up routine. If parameters P0156, P0157 and P0158 are manually adjusted, the maximum allowed value is $1.05 \times P0401$.



ATTENTION!

If a disconnect switch or a contactor is installed between the inverter and the motor, never operate them with a spinning motor or with voltage at the inverter output.

The characteristics of the cable used for the inverter and motor interconnection, as well as the physical location are extremely important to avoid electromagnetic interference in other equipment and to not affect the life cycle of motor windings and motor bearings controlled by inverters.

Recommendations for the motor cables

Unshielded Cables:

- ☑ Can be used when it is not necessary to meet the European directive of electromagnetic compatibility (2004/108/EC), unless the RFI filters be used as presented in the [Table 3.15 on page 3-47](#) and [Item 3.3.1 Installation on page 3-38](#).
- ☑ Keep motor cables away from other cables (signal cables, sensor cables, control cables, etc.), according to [Table 3.5 on page 3-25](#).
- ☑ The emission of the cables may be reduced by installing them inside a metal conduit, which shall be grounded at both ends.
- ☑ Connect a fourth cable between the motor ground and the inverter ground.



NOTE!

The magnetic field created by the current circulation in these cables may induce current in close metal pieces, heat them, and cause additional electrical losses. Therefore, keep the 3 (three) cables (U, V, W) always together.

Shielded Cables:

- ☑ Are mandatory when the electromagnetic compatibility directive (2004/108/EC) shall be met, as defined by the standard EN 61800-3 "Adjustable Speed Electrical Power Drive Systems", unless the RFI filters be used as presented in the [Table 3.15 on page 3-47](#) and [Item 3.4.1 Conformal Installation on page 3-43](#).

These cables act mainly by reducing the irradiated emission in the radio-frequency range.

- ☑ Are mandatory when RFI filters, internally or externally mounted, are installed at the inverter input, unless the RFI filters be used as presented in the [Table 3.15 on page 3-47](#) and [Item 3.4.1 Conformal Installation on page 3-43](#).
- ☑ In reference to the type and details of installation, follow the recommendations of IEC 60034-25 "Guide for Design and Performance of Cage Induction Motors Specifically Designed for Converter Supply" - refer to a summary in [Figure 3.14 on page 3-25](#). Refer to the standard for further details and eventual modifications related to new revisions.
- ☑ Keep motor cables away from other cables (signal cables, sensor cables, control cables, etc.), according to [Table 3.5 on page 3-25](#).
- ☑ The grounding system shall be well interconnected among the several installation locations such as the grounding points of the motor and the inverter. Voltage difference or impedance between the several points may cause the circulation of leakage currents among the equipment connected to the ground, resulting in electromagnetic interference problems.

Table 3.5 - Minimum separation distance between motor cables and all other cables

Cable Length	Minimum Separation Distance
≤ 30 m (100 ft)	≥ 10 cm (3.94 in)
> 30 m (100 ft)	≥ 25 cm (9.84 in)

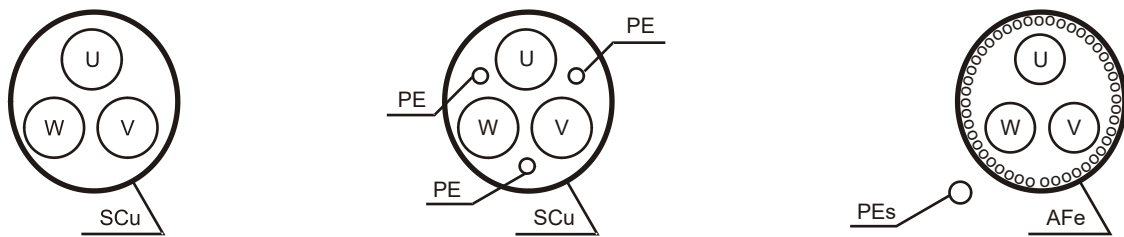

(a) Symmetrical shielded cables: three concentric conductors with or without a ground conductor, symmetrically manufactured, with an external shield of copper or aluminum

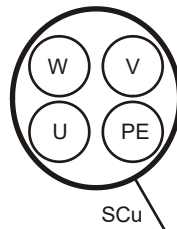

(b) Alternatives for conductors up to 10 mm²

- (1) SCu = copper or aluminum external shielding.
- (2) AFe = steel or galvanized iron.
- (3) PE = ground conductor.
- (4) Cable shielding shall be grounded at both ends (inverter and motor). Use 360° connections for a low impedance to high-frequencies. Refer to [Figure 3.15 on page 3-26](#).
- (5) For using the shield as a protective ground, it shall have at least 50 % of the power cables conductivity. Otherwise, add an external ground conductor and use the shield as an EMC protection.
- (6) Shielding conductivity at high-frequencies shall be at least 10 % of the power cables conductivity.

Figure 3.14 - (a) and (b) - Motor connection cables recommended by IEC 60034-25

Connection of the motor cable shield to ground

The CFW-11 inverter series has some accessories that make the connection of the motor cable shield to the ground easier, resulting in a low impedance connection for high-frequencies.

There is an option accessory for frame sizes A, B, and C with degree of protection IP2X named "Kit for power cables shielding – PCSx-01" (refer to [Section 7.2 ACCESSORIES on page 7-3](#)) that can be adapted in the bottom of the enclosure of these frames. See an example of the cable connection with the accessory PCSx-01 in [Figure 3.15 on page 3-26](#). The kit for power cables shielding is provided for the inverters with internal RFI filters (CFW11XXXXXOFA).

When the "Conduit Kit" (refer to [Section 7.2 ACCESSORIES on page 7-3](#)) is used for frame sizes A, B, and C, motor cable shield shall be grounded similarly as in [Figure 3.15 on page 3-26](#).

For frame size D with degree of protection IP2X/Nema1 and all models with degree of protection IP55, there is a provision for motor cable shield grounding in the standard inverter enclosure.

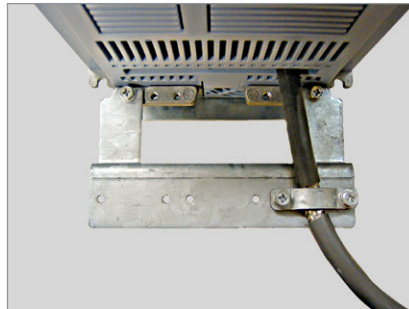

Figure 3.15 - Detail of the motor cable shield connection with the accessory PCSx-01 installed

3.2.4 Grounding Connections



DANGER!

Do not share the grounding wiring with other equipment that operate with high currents (ex.: high power motors, soldering machines, etc.). When installing several inverters, follow the procedures presented in [Figure 3.16 on page 3-27](#) for the grounding connection.



DANGER!

Ne pas partager le câblage de mise à la terre avec d'autres équipements opérant avec des intensités élevées (par ex: moteurs haute puissance, postes de soudure, etc.). Lors de l'installation de plusieurs variateurs, appliquer les procédures présentées dans l'illustration [Figure 3.16 à la page 3-27](#) pour la connexion de mise à la terre.



ATTENTION!

The neutral conductor of the network shall be solidly grounded; however, this conductor shall not be used to ground the inverter.



DANGER!

The inverter must be obligatorily connected to a protective ground (PE).

Observe the following:

- Minimum wire gauge for grounding connection is provided in [Table 3.2 on page 3-14](#). Conform to local regulations and/or electrical codes in case a different wire gauge is required.
- Connect the inverter grounding connections to a ground bus bar, to a single ground point, or to a common grounding point (impedance $\leq 10 \Omega$).
- To comply with IEC 61800-5-1 standard, connect the inverter to the ground by using a single conductor copper cable with a minimum wire gauge of 10 mm² or a two-conductor cable with the same wire gauge of the grounding cable specified in [Table 3.2 on page 3-14](#), since the leakage current is greater than 3.5 mA AC.



DANGER!

Le variateur doit être raccordé à une terre de protection (PE).

Observer les règles suivantes:

- Utilisez la section minimale de raccordement à la terre indiquée dans les [Table 3.2 à la page 3-14](#). Se conformer aux à la réglementation locale et/ou aux codes de l'électricité si une autre épaisseur de fil est nécessaire.
- Connectez la masse du variateur à une barre collectrice de terre en un seul point ou à un point commun de raccordement à la terre (impédance $\leq 10 \Omega$).
- Pour se conformer à la norme CEI 61800-5-1 standard, connectent l'inverseur au sol à l'aide d'un câble cuivre conducteur unique avec un calibre de fil minimum de 10 mm² ou un câble à deux conducteurs avec le même fil de jauge du câble de mise à la terre spécifié dans le [Table 3.2 à la page 3-14](#), depuis le courant de fuite est supérieure à 3,5 mA AC.

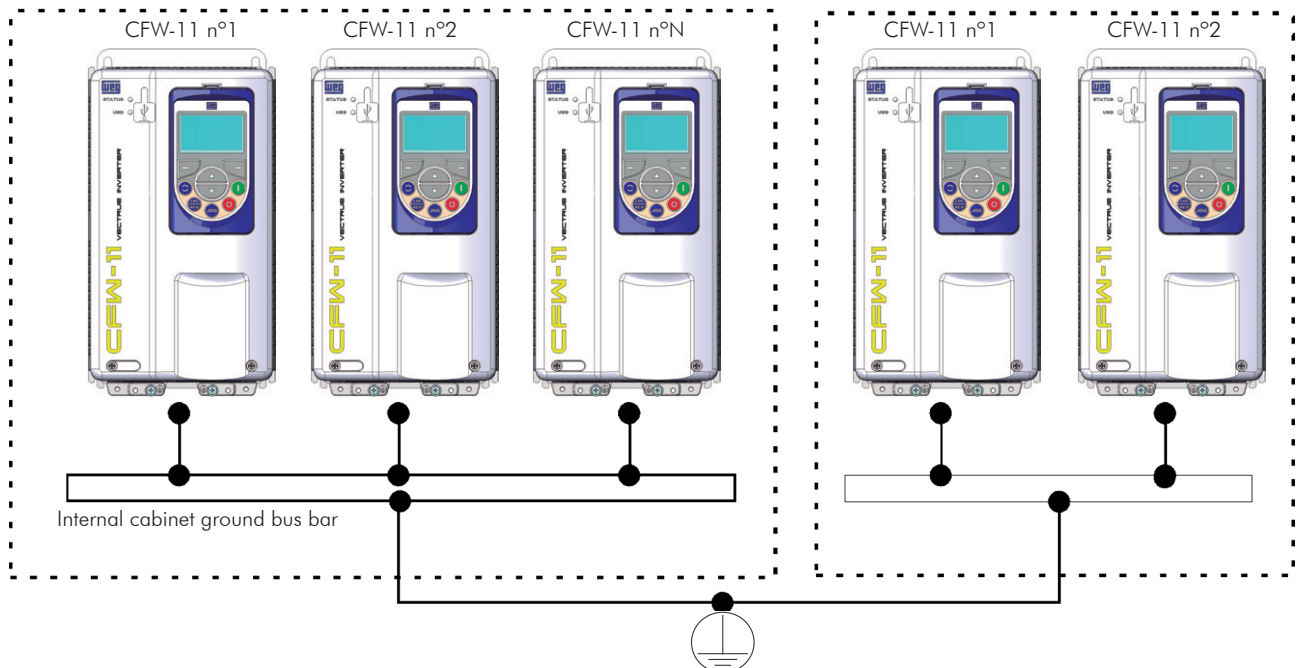
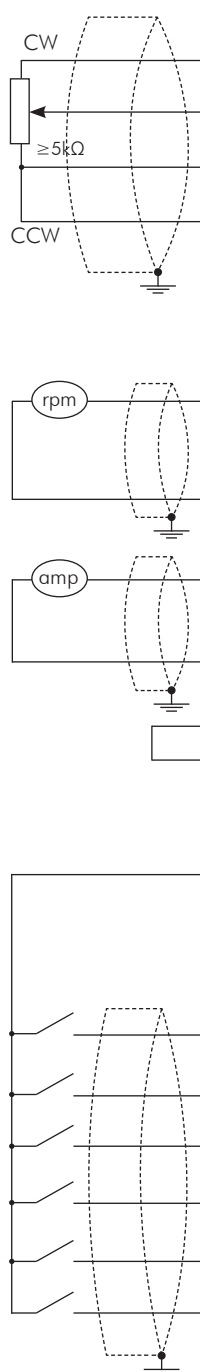

Figure 3.16 - Grounding connections with multiple inverters

3.2.5 Control Connections

The control connections (analog inputs/outputs, digital inputs/outputs), shall be performed in connector XC1 of the CC11 Control Board.

Functions and typical connections are presented in [Figure 3.17 on page 3-29](#).



Connector XC1	Factory Default Function	Specifications	
1	+REF	Positive reference for potentiometer Output voltage: +5.4 V, ±5 %. Maximum output current: 2 mA	
2	AI1+	Analog input #1: Speed reference (remote) Differential Resolution: 12 bits Signal: 0 to 10 V ($R_{IN} = 400\text{ k}\Omega$) / 0 to 20 mA / 4 to 20 mA ($R_{IN} = 500\ \Omega$) Maximum voltage: ±30 V	
3	AI1-		
4	REF-	Negative reference for potentiometer Output voltage: -4.7 V, ±5 %. Maximum output current: 2 mA	
5	AI2+	Analog input #2: No function Differential Resolution: 11 bits + signal Signal: 0 to ±10 V ($R_{IN} = 400\text{ k}\Omega$) / 0 to 20 mA / 4 to 20 mA ($R_{IN} = 500\ \Omega$) Maximum voltage: ±30 V	
6	AI2-		
7	AO1	Analog output #1: Speed Galvanic Isolation Resolution: 11 bits Signal: 0 to 10 V ($R_L \geq 10\text{ k}\Omega$) / 0 to 20 mA / 4 to 20 mA ($R_L \leq 500\ \Omega$) Protected against short-circuit.	
8	AGND (24 V)	Reference (0 V) for the analog outputs Connected to the ground (frame) through impedance: 940 Ω resistor in parallel with a 22 nF capacitor.	
9	AO2	Analog output #2: Motor current Galvanic Isolation Resolution: 11 bits Signal: 0 to 10 V ($R_L \geq 10\text{ k}\Omega$) / 0 to 20 mA / 4 to 20 mA ($R_L \leq 500\ \Omega$) Protected against short-circuit.	
10	AGND (24 V)	Reference (0 V) for the analog outputs Connected to the ground (frame) through impedance: 940 Ω resistor in parallel with a 22 nF capacitor.	
11	DGND*	Reference (0 V) for the 24 Vdc power supply Connected to the ground (frame) through impedance: 940 Ω resistor in parallel with a 22 nF capacitor.	
12	COM	Common point of the digital inputs	
13	24 Vdc	24 Vdc power supply 24 Vdc power supply, ±8 %. Capacity: 500 mA. Note: In the models with the 24 Vdc external control power supply (CFW11XXXXXOW) the terminal 13 of XC1 becomes an input, i.e., the user must connect a 24 V power supply for the inverter (refer to the Item 7.1.2 24 Vdc External Control Power Supply on page 7-2 for more details). In all the other models this terminal is an output, i.e., the user has a 24 V power supply available there.	
14	COM	Common point of the digital inputs	
15	DI1	Digital input #1: Start / Stop 6 isolated digital inputs High level ≥ 18 V Low level ≤ 3 V Maximum input voltage = 30 V Input current: 11 mA @ 24 Vdc	
16	DI2	Digital input #2: Direction of rotation (remote)	
17	DI3	Digital input #3: No function	
18	DI4	Digital input #4: No function	
19	DI5	Digital input #5: Jog (remote)	
20	DI6	Digital input #6: 2 nd ramp	
21	NC1	Digital output #1 DO1 (RL1): No fault	Contact rating: Maximum voltage: 240 Vac Maximum current: 1 A NC - Normally closed contact C - Common NO - Normally open contact
22	C1		
23	NO1		
24	NC2	Digital output #2 DO2 (RL2): $N > N_x$ - Speed > P0288	
25	C2		
26	NO2		
27	NC3	Digital output #3 DO3 (RL3): $N^* > N_x$ - Speed reference > P0288	
28	C3		
29	NO3		

(a) Signals at connector XC1 - Digital inputs working as 'Active High'

Connector XC1	Factory Default Function	Specifications
1	+REF	Positive reference for potentiometer Output voltage: +5.4 V, ±5 %. Maximum output current: 2 mA
2	AI1 +	Analog input #1: Speed reference (remote) Differential Resolution: 12 bits Signal: 0 to 10 V ($R_{IN} = 400\text{ k}\Omega$) / 0 to 20 mA / 4 to 20 mA ($R_{IN} = 500\ \Omega$) Maximum voltage: ±30 V
3	AI1 -	
4	REF-	Negative reference for potentiometer Output voltage: -4.7 V, ±5 %. Maximum output current: 2 mA
5	AI2 +	Analog input #2: No function Differential Resolution: 11 bits + signal Signal: 0 to ±10 V ($R_{IN} = 400\text{ k}\Omega$) / 0 to 20 mA / 4 to 20 mA ($R_{IN} = 500\ \Omega$) Maximum voltage: ±30 V
6	AI2 -	
7	AO1	Analog output #1: Speed Galvanic Isolation Resolution: 11 bits Signal: 0 to 10 V ($R_L \geq 10\text{ k}\Omega$) / 0 to 20 mA / 4 to 20 mA ($R_L \leq 500\ \Omega$) Protected against short-circuit.
8	AGND (24 V)	Reference (0 V) for the analog outputs Connected to the ground (frame) through impedance: 940 Ω resistor in parallel with a 22 nF capacitor.
9	AO2	Analog output #2: Motor current Galvanic Isolation Resolution: 11 bits Signal: 0 to 10 V ($R_L \geq 10\text{ k}\Omega$) / 0 to 20 mA / 4 to 20 mA ($R_L \leq 500\ \Omega$) Protected against short-circuit.
10	AGND (24 V)	Reference (0 V) for the analog outputs Connected to the ground (frame) through impedance: 940 Ω resistor in parallel with a 22 nF capacitor.
11	DGND*	Reference (0 V) for the 24 Vdc power supply Connected to the ground (frame) through impedance: 940 Ω resistor in parallel with a 22 nF capacitor.
12	COM	Common point of the digital inputs
13	24 Vdc	24 Vdc power supply 24 Vdc power supply, ±8 %. Capacity: 500 mA. Note: In the models with the 24 Vdc external control power supply (CFW11XXXXXOW) the terminal 13 of XC1 becomes an input, i.e., the user must connect a 24 V power supply for the inverter (refer to the Item 7.1.3 Nema 1 Degree Protection - Frame Sizes A, B and C on page 7-3 for more details). In all the other models this terminal is an output, i.e., the user has a 24 V power supply available there.
14	COM	Common point of the digital inputs
15	DI1	6 isolated digital inputs High level $\geq 18\text{ V}$ Low level $\leq 3\text{ V}$ Input voltage $\leq 30\text{ V}$ Input current: 11 mA @ 24 Vdc
16	DI2	
17	DI3	
18	DI4	
19	DI5	
20	DI6	
21	NC1	Digital output #1 DO1 (RL1): No fault Contact rating: Maximum voltage: 240 Vac Maximum current: 1 A NC - Normally closed contact C - Common NO - Normally open contact
22	C1	
23	NO1	
24	NC2	Digital output #2 DO2 (RL2): $N > N_x$ - Speed > P0288
25	C2	
26	NO2	
27	NC3	Digital output #3 DO3 (RL3): $N^* > N_x$ - Speed reference > P0288
28	C3	
29	NO3	

(b) Signals at connector XC1 - Digital inputs working as 'Active Low'

Figure 3.17 - (a) and (b) - Signals at connector XC1



NOTE!

In order to use the digital inputs as "Active Low", remove the jumper between XC1:11 and 12 and install it between XC1:12 and 13.

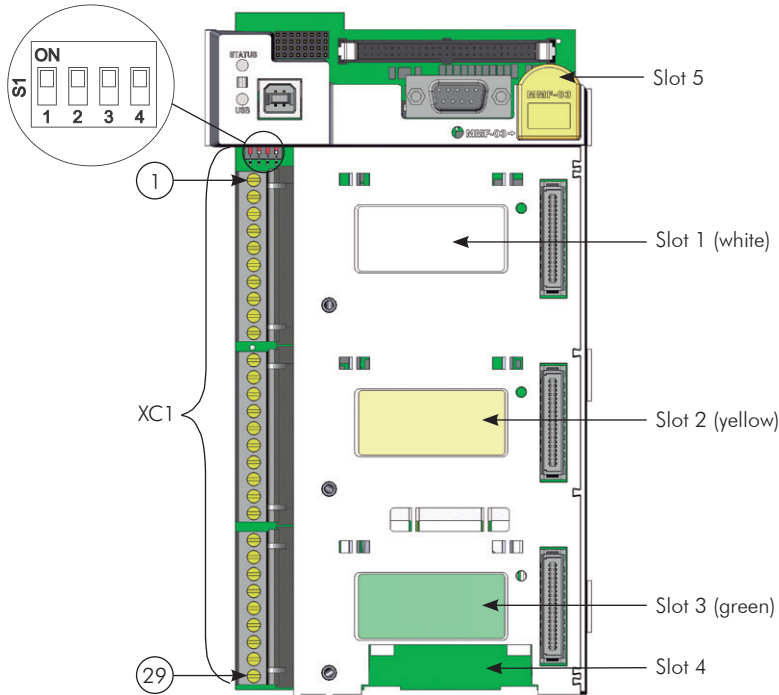

Figure 3.18 - Connector XC1 and DIP-switches for selecting the signal type of the analog inputs and outputs

The analog inputs and outputs are factory set to operate in the range from 0 to 10 V; this setting may be changed by using DIP-switch S1.

Table 3.6 - DIP-switches configuration for the selection of the signal type for the analog inputs and outputs

Signal	Factory Default Function	DIP-switch	Selection	Factory Setting
AI1	Speed reference (remote)	S1.4	OFF: 0 to 10 V (factory setting) ON: 4 to 20 mA / 0 to 20 mA	OFF
AI2	No function	S1.3	OFF: 0 to ±10 V (factory setting) ON: 4 to 20 mA / 0 to 20 mA	OFF
AO1	Speed	S1.1	OFF: 4 to 20 mA / 0 to 20 mA ON: 0 to 10 V (factory setting)	ON
AO2	Motor current	S1.2	OFF: 4 to 20 mA / 0 to 20 mA ON: 0 to 10 V (factory setting)	ON

Parameters related to the analog inputs and outputs (AI1, AI2, AO1, and AO2) shall be programmed according to the DIP-switches settings and desired values.

Follow instructions below for the proper installation of the control wiring:

1. Wire gauge: 0.5 mm² (20 AWG) to 1.5 mm² (14 AWG).
2. Maximum tightening torque: 0.50 N.m (4.50 lbf.in).
3. Use shielded cables for the connections in XC1 and run the cables separated from the remaining circuits (power, 110 V / 220 Vac control, etc.), as presented in Table 3.7 on page 3-31. If control wiring must cross other cables (power cables for instance), make it cross perpendicular to the wiring and provide a minimum separation of 5 cm (1.9 in) at the crossing point.

Table 3.7 - Minimum separation distances between wiring

Cable Length	Minimum Separation Distance
≤ 30 m (100 ft)	≥ 10 cm (3.94 in)
> 30 m (100 ft)	≥ 25 cm (9.84 in)

- The adequate connection of the cable shield is shown in [Figure 3.19](#) on page 3-31 and [Figure 3.20](#) on page 3-31 shows how to connect the cable shield to the ground.

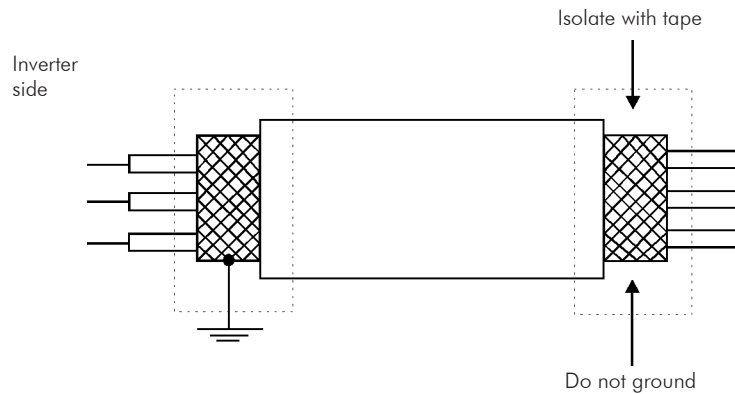

Figure 3.19 - Shield connection

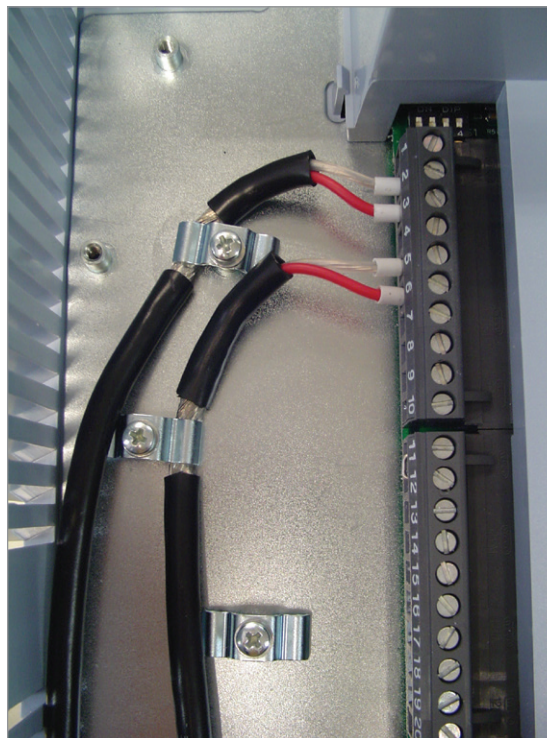

Figure 3.20 - Example of shield connection for the control wiring

- Relays, contactors, solenoids or coils of electromechanical brakes installed close to the inverter may eventually create interferences in the control circuitry. To eliminate this effect, RC suppressors (with AC power supply) or free-wheel diodes (with DC power supply) shall be connected in parallel to the coils of these devices.
- On inverters of frame size D IP2X/Nema1, a shield kit is supplied for better organization of the cables of the communication network. For further information, refer to the installation data sheet supplied with the kit.

3.2.6 Typical Control Connections



Control connection 1 - Start/Stop function controlled from the keypad (Local Mode).

With this control connection it is possible to run the inverter in local mode with the factory default settings. This operation mode is recommended for first-time users, since no additional control connections are required.

For the start-up in this operation mode, please follow instructions listed in [Chapter 5 FIRST TIME POWER-UP AND START-UP](#) on page 5-1.

Control connection 2 - 2 - Wire Start/Stop function (Remote Mode).

This wiring example is valid only for the default factory settings and if the inverter is set to remote mode.

With the factory default settings, the selection of the operation mode (Local/Remote) is performed through the operator key  (local mode is default). Set P0220 = 3 to change the default setting of operator key  to remote mode.

3

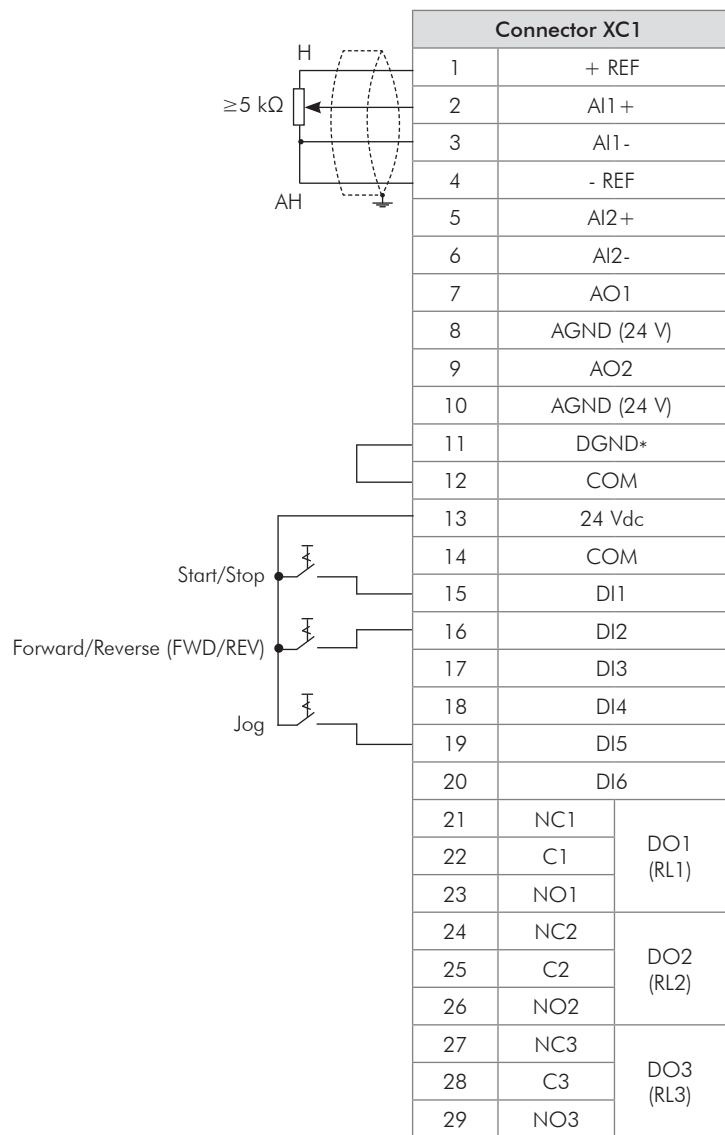

Figure 3.21 - XC1 wiring for control connection #2

Control connection 3 - 3 - Wire Start/Stop function.

Enabling the Start/Stop function with 3 Wire control.

Parameters to set:

Set DI3 to START.

P0265 = 6.

Set DI4 to STOP.

P0266 = 7.

Set P0224 = 1 (DIx) for 3 wire control in Local mode.

Set P0227 = 1 (DIx) for 3 wire control in Remote mode.

Set the Forward/Reverse selection by using digital input # 2 (DI2).

Set P0223 = 4 to Local Mode or P0226 = 4 to Remote mode.

S1 and S2 are Start (NO contact) and Stop (NC contact) push-buttons respectively.

The speed reference can be provided through the analog input (as in Control Connection #2), through the keypad (as in control connection #1) or through any other available source.

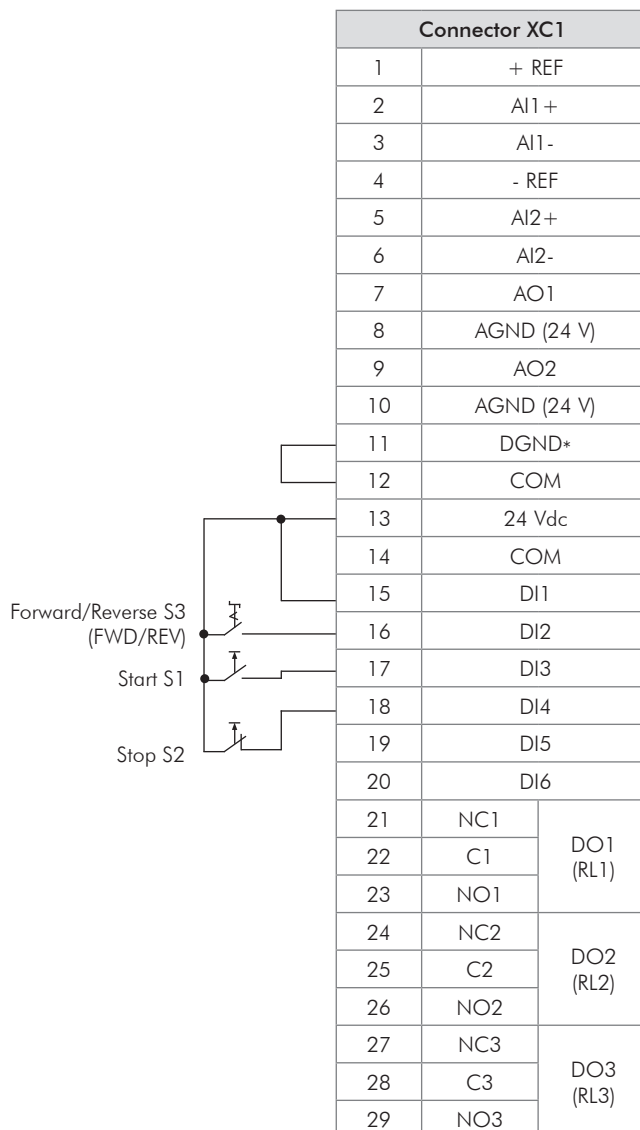

Figure 3.22 - XC1 wiring for control connection #3

Control connection 4 - Forward/Reverse.

Enabling the Forward/Reverse function.



Parameters to set:

Set DI3 to FORWARD.

P0265 = 4.

Set DI4 to REVERSE.

P0266 = 5.

When the Forward/Reverse function is set, it will be active either in Local or Remote mode. At the same time, the operator keys  and  will remain always inactive (even if P0224 = 0 or P0227 = 0).

The direction of rotation is determined by the forward and reverse inputs.

Clockwise to forward and counter-clockwise to reverse.

The speed reference can be provided by any source (as in control connection #3).

3

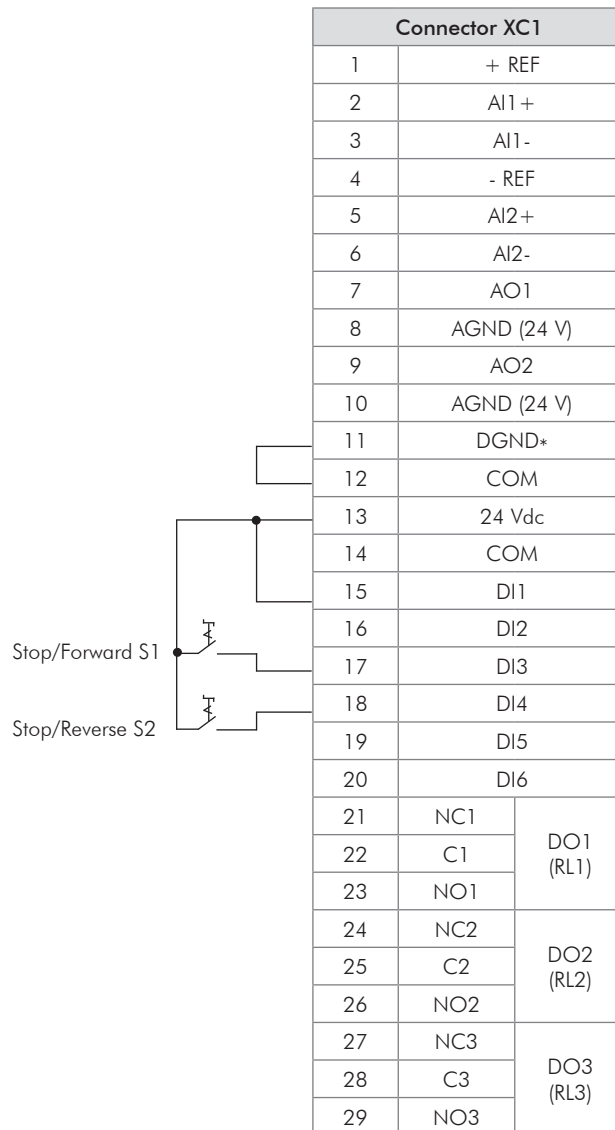

Figure 3.23 - XC1 wiring for control connection #4

3.3 SAFETY STOP FUNCTION

The inverters CFW11...O...Y... have the board SRBXX that implements Safety Stop function. Through this board it is possible to control two safety relays (K1 and K2) that actuate directly on the power circuit, more specifically on the IGBTs gate drivers power supply. The basic functional block diagram is shown in [Figure 3.24 on page 3-35](#).

The safety relays guarantee that the IGBTs remain switched off when Safety Stop function is activated, even in case of an internal single failure. The position of SRBXX board and XC25 terminals (Safety Stop control terminals) on the inverter is shown in [Figure 3.25 on page 3-37](#).

The Safety Stop function prevents the motor starting accidentally.

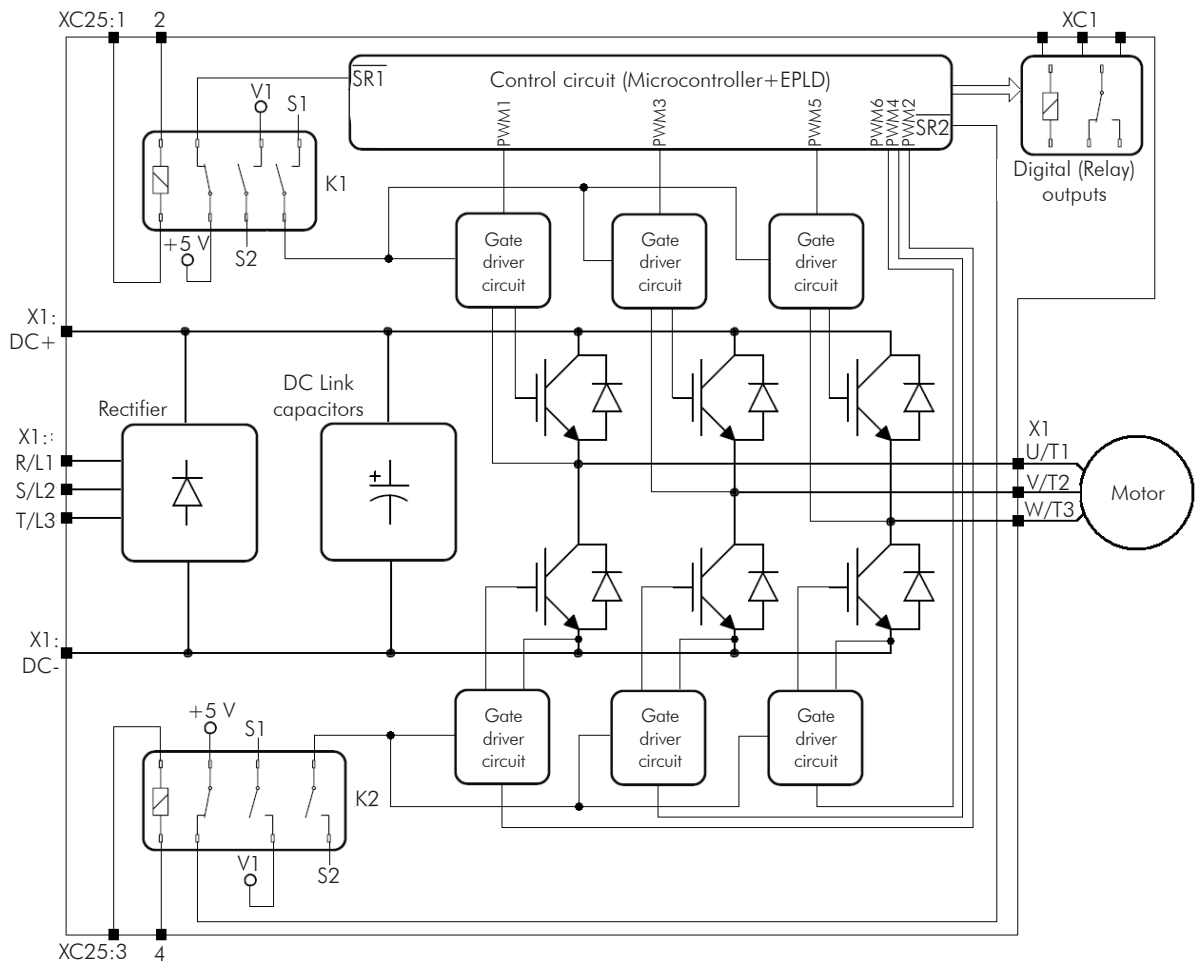

Note:

V1 = inverter internal voltage.

Figure 3.24 - Basic block diagram of Safety Stop function available in CFW-11 inverter series



DANGER!

The activation of the Safety Stop function does not guarantee electrical safety of the motor terminals (they are not isolated from the power supply in this condition).



DANGER!

L'activation de la fonction d'arrêt de sécurité ne garantit pas la sécurité électrique des bornes du moteur (elles ne sont pas isolées de l'alimentation électrique dans cet état).



ATTENTION!

In case of a multiple fault in the power stage of the inverter, the motor shaft can rotate up to 360/ (number of poles) degrees even with the activation of Safety Stop function. That must be considered in the application.



NOTE!

Inverter Safety Stop function is only one component of the safety control system of a machine and/or process. When inverter and its Safety Stop function is correctly used and with other safety components, it's possible to fulfill the requirements of standard ISO 13849-1, Category 3 (machine safety) and IEC/EN 61508, SIL2 (safety control/signaling applied to processes and systems).



(a) Inverters CFW-11 frame size A

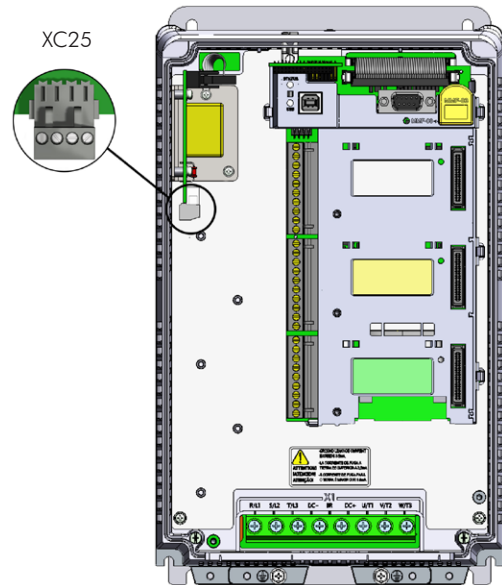

(b) Inverters CFW-11 frame sizes B and C - with IP2X degree of protection or Nema 1

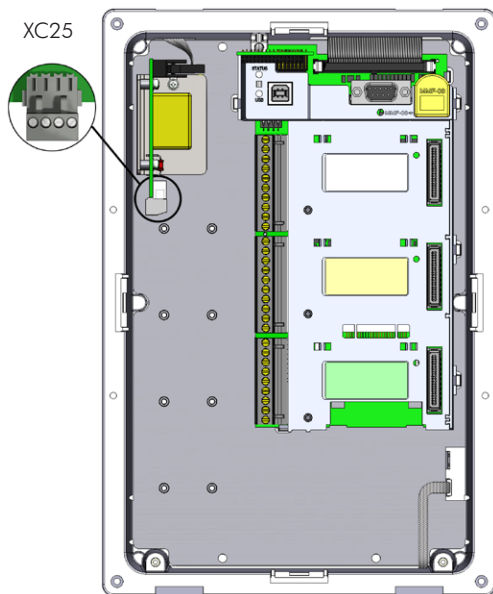

(c) Inverter CFW-11 frame size D - with degree of protection IP2X/Nema1 and all CFW-11 Inverters with degree of protection IP55

Figure 3.25 - (a) to (c) - SRBXX board connections (Safety Stop function)

The parameter P0029 shows if the inverter has identified correctly SRBXX board. See Bit 9 in [Table 3.8 on page 3-38](#).

Table 3.8 - Content of P0029 parameter

Bits															
15	14	13	12	11	10	9	8	7	6	5	4	3	2	1	0
1	1	0	0 = with braking IGBT 1 = without braking IGBT	0	0 = control circuit is supplied from an external +24 Vdc power supply 1 = control circuit is fed by the inverter SMPS	0 = inverter without safety stop option 1 = inverter with Safety Stop option	0 = inverter without RFI filter 1 = inverter with RFI filter	Voltage rating of the inverter: 00 = 200...240 V 01 = 380...480 V 10 = 500...600 V 11 = 500...690 V or 660/690 V			Inverter output rated current				
Hexadecimal digit #4				Hexadecimal digit #3				Hexadecimal digit #2				Hexadecimal digit #1			

3.3.1 Installation



NOTE!

If the degree of protection of the used inverter is lower than IP54, it must be installed inside an IP54 (minimum) cabinet.

Table 3.9 - XC25 terminals (Safety Stop terminals) signals

XC25 Terminals	Function	Specifications
1	STO1	Coil rated voltage: 24 V, range: 20...30 Vdc Coil resistance: 960 Ω ± 10 % @ 20 °C (68 °F)
2	GND1	
3	STO2	Coil rated voltage: 24 V, range: 20...30 Vdc Coil resistance: 960 Ω ± 10 % @ 20 °C (68 °F)
4	GND2	



NOTE!

Terminals XC25: 2 and XC25:4 are not internally connected to the reference of the inverter power supply +24 V. These terminals are often connected to the control terminal XC1:11.



NOTE!

Follow recommendations of [Item 3.2.5 Control Connections on page 3-28](#).

For XC25 control cabling considers the following:

- ☑ Use wire gauge from 0.5 mm² (20 AWG) to 1.5 mm² (14 AWG) and maximum tightening torque of maximum 0.50 N.m (4.50 lbf.in).
- ☑ Use shielded cables connected to ground only on inverter side. Use the provided metallic pieces as shown on [Figure 3.20 on page 3-31](#).
- ☑ Run the cables separated from the remaining circuits (power, 110 V / 220 Vac control, etc.).

3.3.2 Operation

3.3.2.1 Truth Table

Table 3.10 - Safety Stop function operation

STO1 Logic Level (Voltage Between XC25:1-2 Terminals)	STO2 Logic Level (Voltage Between XC25:3-4 Terminals)	Safety Stop Function	Inverter Behavior
0 (0 V)	0 (0 V)	Activated (enabled)	Inverter remains in STO state and does not accept commands. In order to escape this condition, it's required to have STO1 = 1 and STO2 = 1 simultaneously
0 (0 V)	1 (24 V)	Fault	Inverter is tripped by F160 fault (Safety Stop function related fault). To escape this 1 (24 V) 0 (0 V) condition, it's required to reset the inverter
1 (24 V)	0 (0 V)		
1 (24 V)	1 (24 V)	Disabled	Inverter accepts commands normally



NOTE!

Maximum delay between STO1 and STO2 signals: 100 ms (otherwise inverter will be tripped by F160 fault).

Safety Stop function takes priority over all other functions of the inverter.

This function should not be used as a control for starting and/or stopping the inverter.

3.3.2.2 State of Inverter, Fault and Alarm Related to Safety Stop Function

Table 3.11 - State of inverter, fault and alarm related to Safety Stop function

State/Fault/Alarm	Description	Cause
STO state	Safety Stop activated	Voltage between terminals 1 and 2 (relay K1 coil) and between terminals 3 and 4 (relay K2 coil) of XC25 lower than 17 V
F160 fault	Safety Stop function fault	It's applied voltage to relay K1 coil (STO1) but it's not applied voltage to relay K2 coil (STO2) or vice-versa or there is a delay of more than 100 ms between one signal and the other. To solve it, correct the external circuit that generates STO1 and STO2 signals

3.3.2.3 STO Status Indication

State of the inverter is shown on the left upper side of the display and in parameter P0006.

Possible states of the inverter: ready, run (inverter enabled), undervoltage, fault, self-tuning, configuration, DC braking and STO (Safety Stop function activated).

It's possible to set one or more digital and relay outputs of the inverter to indicate that Safety Stop function is activated (state of the inverter = STO), if the inverter is or not on a fault state and more specifically if the inverter was tripped by F160 fault (Safety Stop function fault). For that use the parameters P0275 (DO1), P0276 (DO2), P0277 (DO3), P0278 (DO4) and P0279 (DO5) according to [Table 3.12 on page 3-40](#).

Table 3.12 - P0275...P0279 options for indication of state of inverter or faults on DOx digital outputs

DOx Digital Output Function	Value to Be Set on P0275...P0279	Comment
State of the inverter = STO (Safety Stop function activated)	33	Safety Stop function disabled: relay/transistor OFF Safety Stop function activated: relay/transistor ON
F160 fault (inverter tripped by Safety Stop function fault actuation)	34	Without F160 fault: relay/transistor OFF With fault F160: relay/transistor ON
Fault (inverter tripped by actuation of any fault)	13	Without fault: relay/transistor OFF With fault: relay/transistor ON
Without fault (state of the inverter is not fault)	26	With fault: relay/transistor OFF Without fault: relay/transistor ON

Refer to inverter programming manual for a complete list of options for parameters P0275...P0279.

3.3.2.4 Periodic Test

Safety Stop function, alternatively safety stop inputs (STO1 and STO2), must be activated at least once a year for preventive maintenance purposes. Inverter power supply must be switched off and then on again before carrying out this preventive maintenance. If during testing the power supply to the motor is not switched off, safety integrity is no longer assured for the Safety Stop function. The drive must therefore be replaced to ensure the operational safety of the machine or of the system process.

3.3.3 Examples of Wiring Diagrams of Inverter Control Signal

It is recommended to use inverter DI1 and DI2 digital inputs set as 3-wire Start/Stop commands and the wiring diagrams of inverter control signal according to [Figure 3.22 on page 3-33](#).

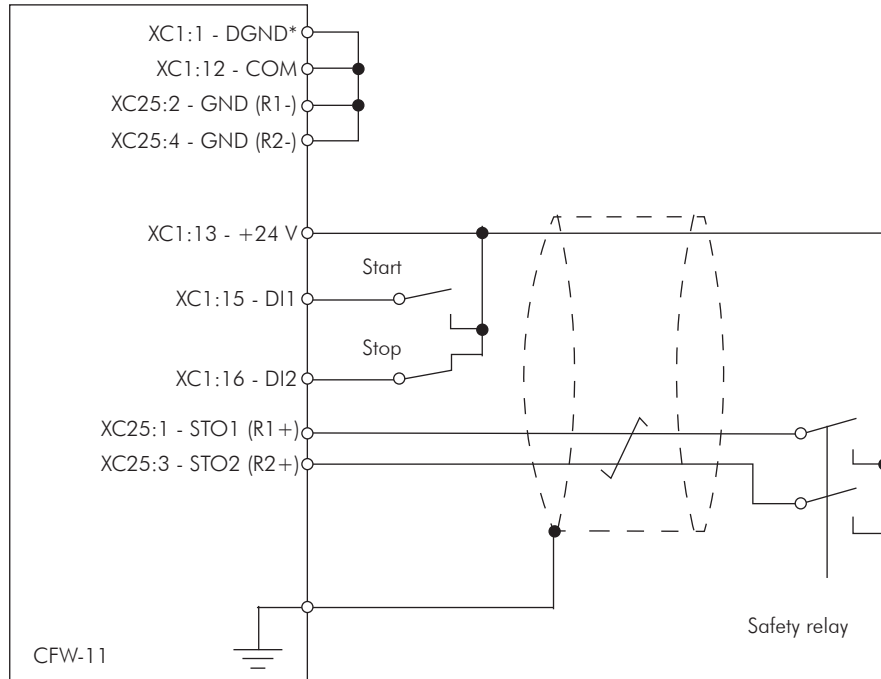

(a) STO or SS0 safety function (without an external safety relay)

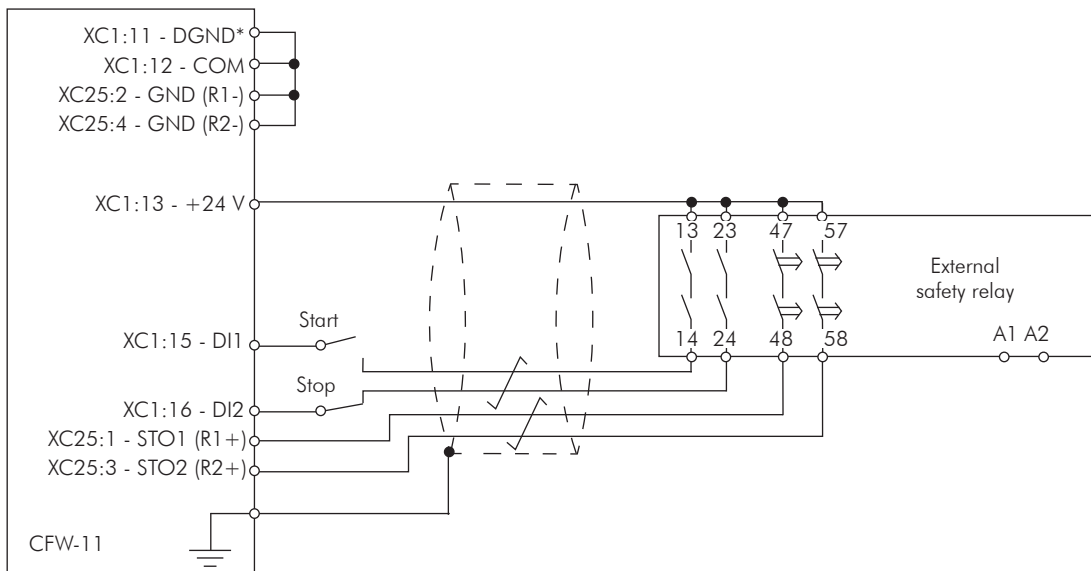

(b) SS1 safety function with an external safety relay (*)

(*) For specifications of external safety relay, which is required to realize SS1 (stop category 1), refer to [Item 3.3.4 Technical Specifications on page 3-42](#).

Figure 3.26 - (a) and (b) - Inverter control wiring examples (XC1 and XC25 terminals) to realize STO (or SS0, i.e., stop category 0) and SS1 (stop category 1) safety functions according to IEC/EN 61800-5-2 and IEC/EN 60204-1 standards - DI1 and DI2 inputs set as 3-wire Start/Stop commands

Circuit operation of SS1 function from [Figure 3.26 on page 3-41](#):

In this case, when the activation command is given to the external safety relay, safety relay opens inverter DI2 signal (via terminals 23 to 24) and motor is decelerated first by the inverter (via deceleration ramp). When the time delay set at the external safety relay expires (this delay must be higher than required time to stop the motor, taking into account deceleration time set on the inverter and inertia of the motor load), the safety relay delayed contacts (terminals 47 to 48 and 57 to 58) opens inverter STO1 and STO2 signals and the inverter Safety Stop function is activated. The motor stops according to category 1 (SS1) of standard IEC/EN 60204-1.

In order to drive the motor again, it is required to apply STO1 and STO2 signals again (to close terminals 13 to 23 and 23 to 24) and apply a pulse on inverter DI1 input (START).

3.3.4 Technical Specifications

3.3.4.1 Electrical Control Characteristics

External safety relay specifications (only when SS1 function is required according to IEC/EN 61800-5-2 and IEC/EN 60204-1 standards) refer to Figure 3.26 on page 3-41	General requirements	IEC 61508 and/or EN 954-1 and/or ISO 13849-1
	Output requirements	Number of current paths: 2 independent paths (one for each STO path) Switching voltage capability: 30 Vdc per contact Switching current capability: 100 mA per contact Maximum switching delay between contacts: 100 ms
	Example	Type/manufacturer: WEG/ Instrutech CPT-D

3.3.4.2 Operational Safety Characteristics

Protection	Of the machine	Safety Stop function which forces stopping and/or prevents the motor from restarting unintentionally, conforming to EN 954-1 / ISO 13849-1 category 3, IEC/EN 61800-5-2 and IEC/EN 60204-1
	Of the system process	Safety Stop function which forces stopping and/or prevents the motor from restarting unintentionally, conforming to IEC/EN 61508 level SIL2 and IEC/EN 61800-5-2

3.4 INSTALLATION ACCORDING TO THE EUROPEAN DIRECTIVE OF ELECTROMAGNETIC COMPATIBILITY

The inverters with the option FA (CFW11XXXXXOFA) are equipped with an internal RFI filter to reduce the electromagnetic interference. These inverters, when properly installed, meet the requirements of the electromagnetic compatibility directive - "EMC Directive 2004/108/EC".

The CFW-11 inverter series has been designed only for industrial applications. Therefore, the emission limits of harmonic currents defined by the standards EN 61000-3-2 and EN 61000-3-2/A 14.



ATTENTION!

Do not use inverters with internal RFI filters in IT networks (neutral is not grounded or grounding provided by a high ohm value resistor) or in grounded delta networks ("delta corner earth"), because these type of networks damage the filter capacitors of the inverter.

3.4.1 Conformal Installation

For the conformal installation use:

1. Inverters with internal RFI filters option CFW11XXXXXOFA (with grounding screws of the internal RFI filter capacitors).
2. a) Shielded output cables (motor cables) and connect the shield at both ends (motor and inverter) with a low impedance connection for high frequency. Use the PCSx-01 kit supplied with the frame size A, B and C inverters. For the frame sizes D models, use the clamps supplied with the product. Make sure there is a good contact between the cable shield and the clamps. Refer to the [Figure 3.15 on page 3-26](#) as an example. The required cable separation is presented in [Table 3.5 on page 3-25](#). For further information, please refer to [Item 3.2.3 Power Connections on page 3-16](#).
Maximum motor cable length and conducted and radiated emission levels according to the [Table 3.14 on page 3-46](#). If a lower emission level and/or a longer motor cable were wished, then an external RFI filter must be used at the inverter input. For more information (RFI filter commercial reference, motor cable length and emission levels) refer to the [Table 3.14 on page 3-46](#).
- b) As a second option only for the V/f and VVW control modes when using a sinusoidal output filter:
Output cables (motor cables) that are not shielded can be used, provided that RFI filters are installed at the inverter input and output, as presented in the [Table 3.15 on page 3-47](#). In that table the maximum cable length and the emission levels for each configuration are also presented. Keep the separation from the other cables according to the [Table 3.5 on page 3-25](#). Refer to the [Item 3.2.4 Grounding Connections on page 3-26](#).
3. Shielded control cables, keeping them separate from the other cables as described in [Item 3.2.5 Control Connections on page 3-28](#).
4. Inverter grounding according to the instructions on [Item 3.2.4 Grounding Connections on page 3-26](#).

3.4.2 Standard Definitions

IEC/EN 61800-3: "Adjustable Speed Electrical Power Drives Systems"

- Environment:

First Environment: includes domestic premises. It also includes establishments directly connected without intermediate transformer to a low-voltage power supply network which supplies buildings used for domestic purposes.

Example: houses, apartments, commercial installations, or offices located in residential buildings.

Second Environment: includes all establishments other than those directly connected to a low-voltage power supply network which supplies buildings used for domestic purposes.

Example: industrial area, technical area of any building supplied by a dedicated transformer.

- Categories:

Category C1: inverters with a voltage rating less than 1000 V and intended for use in the First Environment.

Category C2: inverters with a voltage rating less than 1000 V, intended for use in the First Environment, not provided with a plug connector or a movable installations, and installed and commissioned by a professional.

Note: a professional is a person or organization familiar with the installation and/or commissioning of inverters, including the EMC aspects.

Category C3: inverters with a voltage rating less than 1000 V and intended for use in the Second Environment only (not designed for use in the First Environment).

Category C4: inverters with a voltage rating equal to or greater than 1000 V, or with a current rating equal to or greater than 400 Amps, or intended for use in complex systems in the Second Environment.

EN 55011: "Threshold values and measuring methods for radio interference from industrial, scientific and medical (ISM) high-frequency equipment"

Class B: equipment intended for use in the low-voltage power supply network (residential, commercial, and light-industrial environments).

Class A1: equipment intended for use in the low-voltage power supply network. Restricted distribution.

Note: must be installed and commissioned by a professional when applied in the low-voltage power supply network.

Class A2: equipment intended for use in industrial environments.

3.4.3 Emission and Immunity Levels

Table 3.13 - Emission and immunity levels

EMC Phenomenon	Basic Standard	Level
Emission:		
Mains terminal disturbance voltage Frequency range: 150 kHz to 30 MHz	IEC/EN61800-3 (2004) + A1 (2011)	It depends on the inverter model and on the motor cable length. Refer to Table 3.14 on page 3-46
Electromagnetic radiation disturbance Frequency range: 30 MHz to 1000 MHz		
Immunity:		
Electrostatic discharge (ESD)	IEC 61000-4-2 (2008)	4 kV for contact discharge and 8 kV for air discharge
Fast transient-Burst	IEC 61000-4-4 (2012)	2 kV / 5 kHz (coupling capacitor) power input cables 1 kV / 5 kHz control cables, and remote keypad cables 2 kV / 5 kHz (coupling capacitor) motor output cables
Conducted radio-frequency common mode	IEC 61000-4-6 (2013)	0.15 to 80 MHz; 10 V; 80 % AM (1 kHz) Motor cables, control cables, and remote keypad cables
Surge immunity	IEC 61000-4-5 (2014)	1.2/50 μ s, 8/20 μ s 1 kV line-to-line coupling 2 kV line-to-ground coupling
Radio-frequency electromagnetic field	IEC 61000-4-3 (2010)	80 MHz to 1000 GHz 10 V/m 80 % AM (1 kHz)

Table 3.14 - Conducted and radiated emission levels and further information - installations with shield motor cable

Inverter Model (With Built-in RFI Filter)	Without External RFI Filter			External RFI Filter Part Number (Manufacturer: EPCOS) ⁽¹⁾	With External RFI Filter			
	Conducted Emission - Maximum Motor Cable Length		Radiated Emission Category (No Metallic Cabinet Required)		Conducted Emission - Maximum Motor Cable Length		Radiated Emission - Category	
	Category C3	Category C2			Category C2	Category C1	Without Metallic Cabinet	Inside a Metallic Cabinet ⁽³⁾
CFW11 0006 S2 O FA	100 m	7 m	C2	B84142-A16-R122	75 m	50 m	C2	C2
				B84142-B16-R	100 m ⁽²⁾	100 m		
CFW11 0007 T2 O FA	100 m	5 m	C2	B84143-G8-R110	100 m	-	C2	C2
				B84143-A8-R105	50 m ⁽²⁾	50 m		
CFW11 0007 S2 O FA	100 m	7 m	C2	B84142-A16-R122	75 m	50 m	C2	C2
				B84142-B16-R	100 m ⁽²⁾	100 m		
CFW11 0010 S2 O FA	100 m	7 m	C2	B84142-A30-R122	75 m	50 m	C2	C2
				B84142-B25-R	100 m ⁽²⁾	100 m		
CFW11 0010 T2 O FA	100 m	5 m	C2	B84143-G20-R110	100 m	-	C2	C2
				B84143-A16-R105	50 m ⁽²⁾	50 m		
CFW11 0013 T2 O FA	100 m	5 m	C2	B84143-G20-R110	100 m	-	C2	C2
				B84143-A16-R105	50 m ⁽²⁾	50 m		
CFW11 0016 T2 O FA	100 m	5 m	C2	B84143-G20-R110	100 m	-	C2	C2
				B84143-A25-R105	50 m ⁽²⁾	50 m		
CFW11 0024 T2 O FA	100 m	No	C2	B84143-A36-R105	100 m ⁽²⁾	100 m	C2	C2
CFW11 0028 T2 O FA	100 m	No	C2	B84143-A36-R105	100 m ⁽²⁾	100 m	C2	C2
CFW11 0033 T2 O FA	100 m	No	C2	B84143-A50-R105	100 m ⁽²⁾	100 m	C2	C2
CFW11 0045 T2 O FA	100 m	No	C3	B84143-A50-R105	100 m ⁽²⁾	100 m	C3	C2
CFW11 0054 T2 O FA	100 m	No	C3	B84143-A66-R105	100 m ⁽²⁾	100 m	C3	C2
CFW11 0070 T2 O FA	100 m	No	C3	B84143-A90-R105	100 m ⁽²⁾	100 m	C3	C2
CFW11 0086 T2 O FA	100 m	No	C3	B84143-A120-R105	100 m ⁽²⁾	100 m	C3	C2
CFW11 0105 T2 O FA	100 m	No	C3	B84143-A120-R105	100 m ⁽²⁾	100 m	C3	C2
CFW11 0003 T4 O FA	100 m	5 m	C2	B84143-G8-R110	100 m	-	C2	C2
				B84143-A8-R105	50 m ⁽²⁾	50 m		
CFW11 0005 T4 O FA	100 m	5 m	C2	B84143-G8-R110	100 m	-	C2	C2
				B84143-A8-R105	50 m ⁽²⁾	50 m		
CFW11 0007 T4 O FA	100 m	5 m	C2	B84143-G8-R110	100 m	-	C2	C2
				B84143-A8-R105	50 m ⁽²⁾	50 m		
CFW11 0010 T4 O FA	100 m	5 m	C2	B84143-G20-R110	100 m	-	C2	C2
				B84143-A16-R105	50 m ⁽²⁾	50 m		
CFW11 0013 T4 O FA	100 m	5 m	C2	B84143-G20-R110	100 m	-	C2	C2
				B84143-A16-R105	50 m ⁽²⁾	50 m		
CFW11 0017 T4 O FA	100 m	No	C2	B84143-A25-R105	100 m ⁽²⁾	100 m	C2	C2
CFW11 0024 T4 O FA	100 m	No	C2	B84143-A36-R105	100 m ⁽²⁾	100 m	C2	C2
CFW11 0031 T4 O FA	100 m	No	C2	B84143-A36-R105	100 m ⁽²⁾	100 m	C2	C2
CFW11 0038 T4 O FA	100 m	No	C3	B84143-A50-R105	100 m ⁽²⁾	100 m	C3	C2
CFW11 0045 T4 O FA	100 m	No	C3	B84143-A50-R105	100 m ⁽²⁾	100 m	C3	C2
CFW11 0058 T4 O FA	100 m	No	C3	B84143-A66-R105	100 m ⁽²⁾	100 m	C3	C2
CFW11 0070 T4 O FA	100 m	No	C3	B84143-A90-R105	100 m ⁽²⁾	100 m	C3	C2
CFW11 0088 T4 O FA	100 m	No	C3	B84143-A120-R105	100 m ⁽²⁾	100 m	C3	C2

(1) The external RFI filters shown in table above were selected considering inverter rated input current specified for ND application (normal duty cycle) and surrounding air temperature of 50 °C (122 °F). In order to optimize, take into account inverter input current and surrounding air temperature in the application to define the rated current of external RFI filter to be used. For further information contact EPCOS.

(2) It's possible to use larger motor cables, but in this case it's required a specific test.

(3) Standard cabinet without additional EMC measures. It's possible to meet category C1 radiated emission levels, adding EMC accessories in the cabinet.

In this case it's required to perform specific test to check the emission levels.

Table 3.15 - Required RFI filters for unshielded motor cable installations and further information on conducted and radiated levels

Inverter Model (With Built-in RFI Filter)	External RFI Filters Part Number (Manufacturer: EPCOS) ⁽¹⁾		Conducted Emission - Maximum Motor Cable Length	Radiated Emission - Category	
	Inverter Input	Inverter Output ⁽²⁾		Category C1	Without Metallic Cabinet
CFW11 0006 S2 ○ FA	B84142-A16-R122	B84143-V11-R127	250 m	C3	C3
CFW11 0007 T2 ○ FA	B84143-A8-R105	B84143-V11-R127	250 m	C2	C2
CFW11 0007 S2 ○ FA	B84142-A16-R122	B84143-V11-R127	250 m	C3	C3
CFW11 0010 S2 ○ FA	B84142-A30-R122	B84143-V16-R127	250 m	C3	C3
CFW11 0010 T2 ○ FA	B84143-A16-R105	B84143-V16-R127	250 m	C2	C2
CFW11 0013 T2 ○ FA	B84143-A16-R105	B84143-V16-R127	250 m	C2	C2
CFW11 0016 T2 ○ FA	B84143-A25-R105	B84143-V33-R127	250 m	C2	C2
CFW11 0024 T2 ○ FA	B84143-A36-R105	B84143-V33-R127	250 m	C3	C2
CFW11 0028 T2 ○ FA	B84143-A36-R105	B84143-V66-R127	250 m	C3	C2
CFW11 0033 T2 ○ FA	B84143-A50-R105	B84143-V66-R127	250 m	C3	C2
CFW11 0045 T2 ○ FA	B84143-D50-R127	B84143-V66-R127	250 m	C3	C2
CFW11 0054 T2 ○ FA	B84143-D75-R127	B84143-V66-R127	250 m	C3	C2
CFW11 0070 T2 ○ FA	B84143-D75-R127	B84143-V95-R127	250 m	C3	C2
CFW11 0086 T2 ○ FA	B84143-A120-R105	B84143-V180-R127	250 m	C3	C2
CFW11 0105 T2 ○ FA	B84143-A120-R105	B84143-V180-R127	250 m	C3	C2
CFW11 0003 T4 ○ FA	B84143-A8-R105	B84143-V11-R127	250 m	C2	C2
CFW11 0005 T4 ○ FA	B84143-A8-R105	B84143-V11-R127	250 m	C2	C2
CFW11 0007 T4 ○ FA	B84143-A8-R105	B84143-V11-R127	250 m	C2	C2
CFW11 0010 T4 ○ FA	B84143-A16-R105	B84143-V16-R127	250 m	C2	C2
CFW11 0013 T4 ○ FA	B84143-A16-R105	B84143-V16-R127	250 m	C2	C2
CFW11 0017 T4 ○ FA	B84143-A25-R105	B84143-V33-R127	250 m	C3	C2
CFW11 0024 T4 ○ FA	B84143-A36-R105	B84143-V33-R127	250 m	C3	C2
CFW11 0031 T4 ○ FA	B84143-A36-R105	B84143-V66-R127	250 m	C3	C2
CFW11 0038 T4 ○ FA	B84143-D50-R127	B84143-V66-R127	250 m	C3	C2
CFW11 0045 T4 ○ FA	B84143-D50-R127	B84143-V66-R127	250 m	C3	C2
CFW11 0058 T4 ○ FA	B84143-D75-R127	B84143-V95-R127	250 m	C3	C2
CFW11 0070 T4 ○ FA	B84143-A90-R105	B84143-V95-R127	250 m	C3	C2
CFW11 0088 T4 ○ FA	B84143-A120-R105	B84143-V180-R127	250 m	C3	C2

(1) The external RFI filters shown in table above were selected considering inverter rated input/output current specified for ND application (normal duty cycle) and surrounding air temperature of 50 °C (122 °F). In order to optimize, take into account inverter input/output current and surrounding air temperature in the application to define the rated current of external RFI filter to be used. For further information contact EPCOS.

(2) The output filter is of the sinusoidal type, i.e., the motor voltage waveform is approximately sinusoidal, not pulsed as in the applications without this filter.

4 HMI

This chapter contains the following information:

- ☑ The operator keys and their functions.
- ☑ The indications on the display.
- ☑ How parameters are organized.

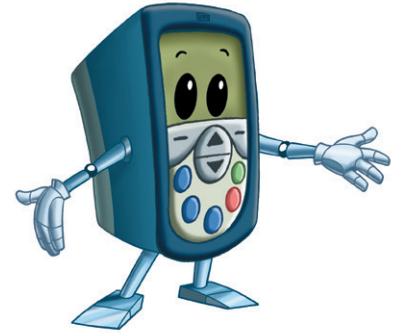

4.1 INTEGRAL KEYPAD - HMI-CFW11

The integral keypad can be used to operate and program (view/edit all parameters) of the CFW-11 inverter.

The inverter keypad navigation is similar to the one used in cell phones and the parameters can be accessed in numerical order or through groups (Menu).

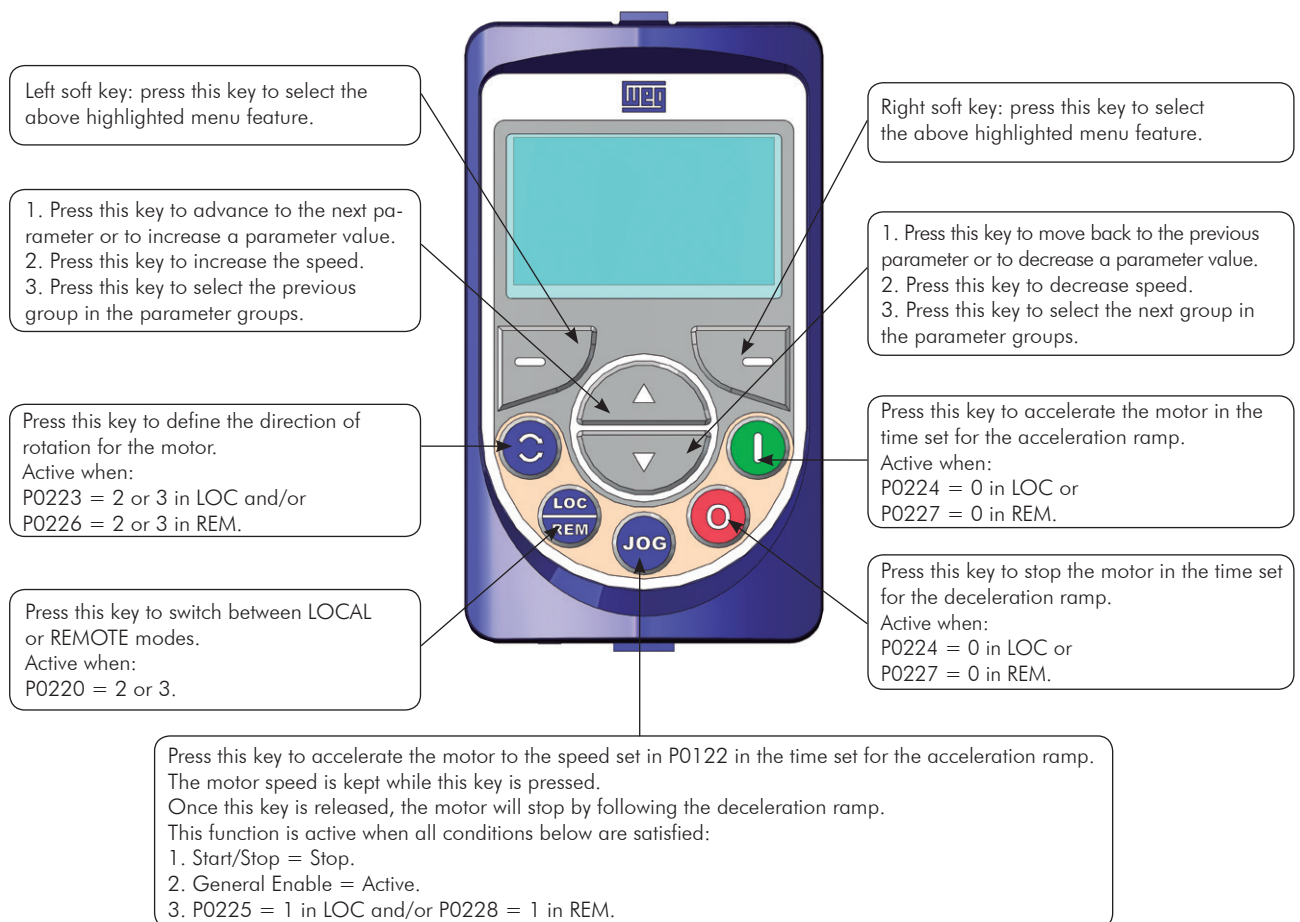

Figure 4.1 - Operator keys

Battery:



NOTE!

The battery is only required for the clock-related functions. If the battery is completely discharge or if it not installed in the keypad, the displayed clock time will be invalid and an alarm condition "A181 - Invalid clock time" will be indicated whenever the AC power is applied to the inverter.

The battery life expectancy is of approximately 10 years. When necessary, replace the battery by another of the CR2032 type.



Cover for battery access



Press the cover and rotate it counterclockwise



Remove the cover

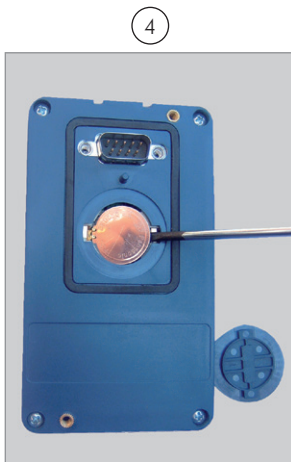

Remove the battery with the help of a screwdriver positioned in the right side



HMI without the battery



Install the new battery positioning it first at the left side



Press the battery for its insertion



Put the cover back and rotate it clockwise

Figure 4.2 - HMI battery replacement



NOTE!

At the end of the battery useful life, please do not discard batteries in your waste container, but use a battery disposal site.

Installation:

- ☑ The keypad can be installed or removed from the inverter with or without AC power applied to the inverter.

- ☑ The HMI supplied with the product can also be used for remote command of the inverter. In this case, use a cable with male and female D-Sub9 (DB-9) connectors wired pin to pin (mouse extension type) or a market standard Null-Modem cable. It is recommended the use of the M3 x 5.8 standoffs supplied with the product. Recommended torque: 0.5 Nm (4.5 lbf in).

When power is applied to the inverter, the display automatically enters the monitoring mode. [Figure 4.3 on page 4-4](#) presents the monitoring screen displayed for the factory default settings. By properly setting specific inverter parameters, other variables can be displayed in the monitoring mode or the value of a parameter can be displayed using bar graphs or with larger characters as presented in [Figure 4.3 on page 4-4](#).

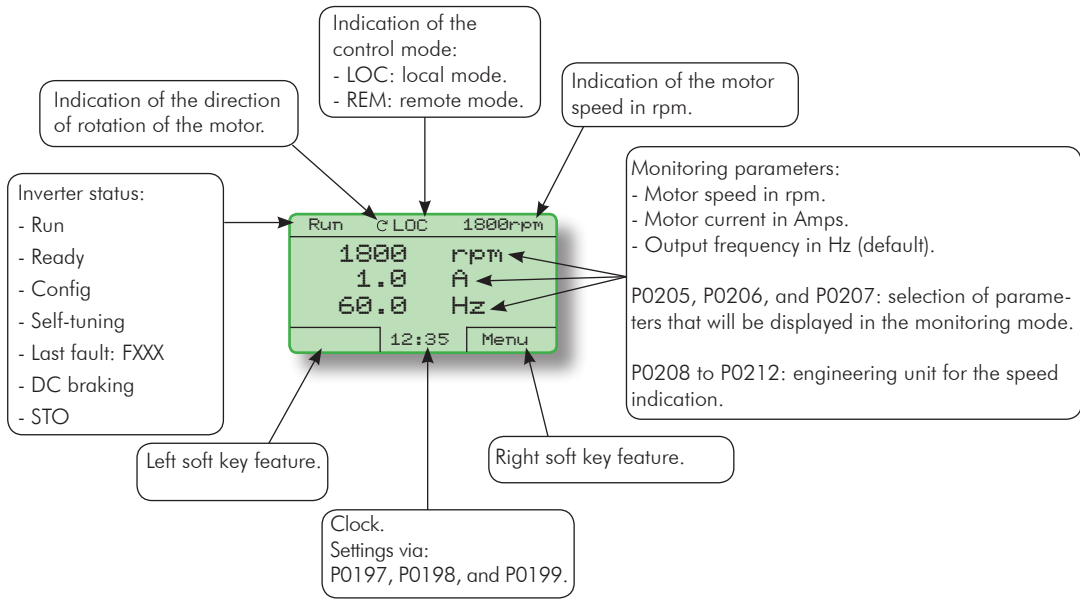

(a) Monitoring screen with the factory default settings

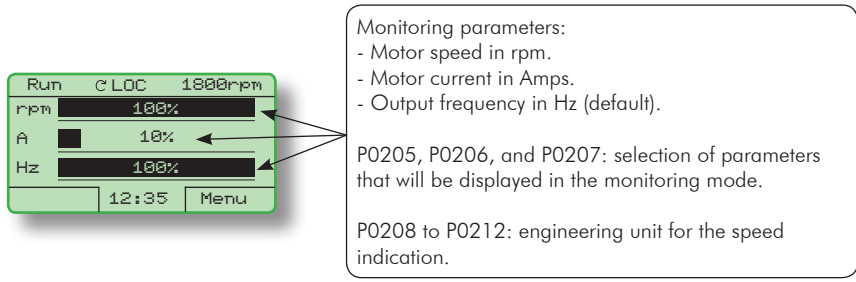

(b) Example of a monitoring screen with bar graphs

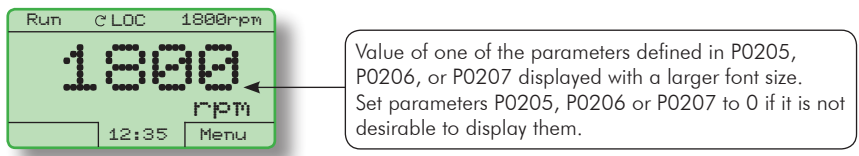

(c) Example of a monitoring screen displaying a parameter with a larger font size

Figure 4.3 - (a) to (c) - Keypad monitoring modes

4.2 PARAMETERS ORGANIZATION

When the right soft key ("MENU") is pressed in the monitoring mode, the display shows the first 4 groups of parameters. An example of how the groups of parameters are organized is presented in [Table 4.1 on page 4-5](#). The number and name of the groups may change depending on the firmware version used. For further details on the existent groups for the firmware version used, please refer to the programming manual.

Table 4.1 - Groups of parameters

Level 0	Level 1		Level 2		Level 3			
Monitoring	00	ALL PARAMETERS						
	01	PARAMETER GROUPS	20	Ramps				
			21	Speed References				
			22	Speed Limits				
			23	V/f Control				
			24	Adjust. V/f Curve				
			25	VVW Control				
			26	V/f Current Limit.				
			27	V/f DC Volt. Limit.				
			28	Dynamic Braking				
			29	Vector Control			90	Speed Regulator
							91	Current Regulator
							92	Flux Regulator
							93	I/F Control
							94	Self-Tuning
							95	Torque Curr.Limit.
							96	DC Link Regulator
					30	HMI		
					31	Local Command		
					32	Remote Command		
					33	3-Wire Command		
					34	FWD/REV Run Comm.		
					35	Zero Speed Logic		
					36	Multispeed		
					37	Electr. Potentiom.		
					38	Analog Inputs		
					39	Analog Outputs		
					40	Digital Inputs		
					41	Digital Outputs		
					42	Inverter Data		
			43	Motor Data				
			44	FlyStart/RideThru				
			45	Protections				
		46	PID Regulator					
		47	DC Braking					
		48	Skip Speed					
		49	Communication					
				110	Local/Rem Config.			
				111	Status/Commands			
				112	CANopen/DeviceNet			
				113	Serial RS232/485			
				114	Anybus			
				115	Profibus DP			
		50	SoftPLC					
		51	PLC					
		52	Trace Function					
	02	ORIENTED START-UP						
	03	CHANGED PARAMETERS						
	04	BASIC APPLICATION						
	05	SELF-TUNING						
	06	BACKUP PARAMETERS						
	07	I/O CONFIGURATION	38	Analog Inputs				
			39	Analog Outputs				
			40	Digital Inputs				
			41	Digital Outputs				
	08	FAULT HISTORY						
	09	READ ONLY PARAMS.						

5 FIRST TIME POWER-UP AND START-UP

This chapter describes how to:

- Check and prepare the inverter before power-up.
- Power-up the inverter and check the result.
- Set the inverter for the operation in the V/f mode based on the power supply and motor information by using the Oriented Start-Up routine and the Basic Application group.

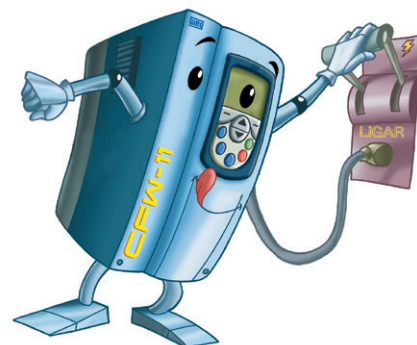

NOTE!

For a detailed description of the VVW or Vector control modes and for other available functions, please refer to the CFW-11 programming manual.



ATTENTION!

Firmware version V5.00 or higher **CANNOT** be used on inverters with control board revision prior to "D". Any firmware version prior to V5.00 **CANNOT** be used on inverters with control board revision "D" or higher.

5.1 PREPARE FOR START-UP

The inverter shall have been already installed according to the recommendations listed in [Chapter 3 INSTALLATION AND CONNECTION](#) on [page 3-1](#). The following recommendations are applicable even if the application design is different from the suggested control connections.



DANGER!

Always disconnect the main power supply before performing any inverter connection.



DANGER!

Débranchez toujours l'alimentation principale avant d'effectuer une connexion sur le variateur.

1. Check if power, grounding, and control connections are correct and firmly secured.
2. Remove from the inside of the inverter all installation material left behind.
3. Verify the motor connections and if the motor voltage and current is within the rated value of the inverter.
4. Mechanically uncouple the motor from the load:
If the motor cannot be uncoupled, make sure that the chosen direction of rotation (forward or reverse) will not result in personnel injury and/or equipment damage.
5. Return the inverter covers.

6. Measure the power supply voltage and verify if it is within the range listed in [Chapter 8 TECHNICAL SPECIFICATIONS](#) on page 8-1.
7. Apply power to the input:
Close the input disconnect switch.
8. Check the result of the first time power-up:
The keypad should display the standar monitoring mode ([Figure 4.3 on page 4-4](#)) and the status LED should be steady green.

5.2 START-UP

The start-up procedure for the V/f is described in three simple steps by using the **Oriented Start-up routine** and the **Basic Application group**.

Steps:

1. Set the password for parameter modification.
2. Execute the **Oriented Start-up routine**.
3. Set the parameters of the **Basic Application group**.

5.2.1 Password Setting in P0000

Step	Action/Result	Display Indication
1	- Monitoring mode - Press "Menu" (right soft key)	
2	- Group "00 ALL PARAMETERS" is already selected - Press "Select"	
3	- Parameter "Access to Parameters P0000: 0" is already selected - Press "Select"	
4	- To set the password, press the Up Arrow until number 5 is displayed in the keypad	
5	- When number 5 is displayed in the keypad, press "Save"	
6	- If the setting has been properly performed, the keypad should display "Access to Parameters P0000: 5" - Press "Return" (left soft key)	
7	- Press "Return"	
8	- The display returns to the monitoring mode	

Figure 5.1 - Steps for allowing parameters modification via P0000

5.2.2 Oriented Start-Up

There is a group of parameters named "Oriented Start-up" that makes the inverter settings easier. Inside this group, there is a parameter – P0317, that shall be set to enter into the Oriented Start-up routine.

The Oriented Start-up routine allows you to quickly set up the inverter for operation with the line and motor used. This routine prompts you for the most commonly used parameters in a logic sequence.

In order to enter into the Oriented Start-up routine, follow the steps presented in Figure 5.2 on page 5-5, first modifying parameter P0317 to 1 and then, setting all remaining parameters as they are prompted in the display.

First Time Power-Up and Start-Up

The use of the Oriented Start-up routine for setting the inverter parameters may lead to the automatic modification of other internal parameters and/or variables of the inverter.

During the Oriented Start-up routine, the message "Config" will be displayed at the left top corner of the keypad.

Step	Action/Result	Display Indication	Step	Action/Result	Display Indication
1	- Monitoring mode - Press "Menu" (right soft key)		2	- Group "00 ALL PARAMETERS " has been already selected 	
3	- Group "01 PARAMETER GROUPS " is selected 		4	- Group "02 ORIENTED START-UP " is then selected - Press "Select"	
5	- Parameter "Oriented Start-Up P0317: No " has been already selected. - Press "Select"		6	- The value of "P0317 = [000] No" is displayed 	
7	- The parameter value is modified to "P0317 = [001] Yes " - Press "Save"		8	- At this point the Oriented Start-up routine starts and the "Config" status is displayed at the top left corner of the keypad - The parameter " Language P0201: English " is already selected - If needed, change the language by pressing "Select" . Then, press or to scroll through the available options and press "Save" to select a different language 	
9	- If needed, change the value of P0202 according to the type of control. To do so, press " Select " - The settings listed here are valid only for P0202=0 (V/f 60 Hz) or P0202=1 (V/f 50 Hz). For other options (Adjustable V/f, VVW, or Vector modes), please refer to the programming manual 		10	- If needed, change the value of P0296 according to the line rated voltage. To do so, press " Select " This modification will affect P0151, P0153, P0185, P0321, P0322, P0323, and P0400 	



Step	Action/Result	Display Indication	Step	Action/Result	Display Indication
11	- If needed, change the value of P0298 according to the inverter application. To do so, press "Select" This modification will affect P0156, P0157, P0158, P0401, P0404 and P0410 (this last one only if P0202 = 0, 1, or 2 – V/f control). The time and the activation level of the overload protection will be affected as well		12	- If needed, change the value of P0398 according to the motor service factor. To do so, press "Select" This modification will affect the current value and the activation time of the motor overload function	
13	- If needed, change the value of P0400 according to the motor rated voltage. To do so, press "Select" This modification adjusts the output voltage by a factor x = P0400/P0296		14	- If needed, change the value of P0401 according to the motor rated current. To do so, press "Select" This modification will affect P0156, P0157, P0158, and P0410	
15	- If needed, set P0402 according to the motor rated speed. To do so, press "Select" . This modification affects P0122 to P0131, P0133, P0134, P0135, P0182, P0208, P0288, and P0289		16	- If needed, set P0403 according to the motor rated frequency. To do so, press "Select" . This modification affects P0402	
17	- If needed, change the value of P0404 according to the motor rated power. To do so, press "Select" This modification affects P0410		18	- This parameter will only be visible if the encoder board ENC1 is installed in the inverter - If there is an encoder connected to the motor, set P0405 according to the encoder pulses number. To do so, press "Select"	
19	- If needed, set P0406 according to the motor ventilation. To do so, press "Select" - To complete the Oriented Start-Up routine, press "Reset" (left soft key) or 		20	- After few seconds, the display returns to the monitoring mode	

Figure 5.2 - Oriented Start-up

5.2.3 Setting Basic Application Parameters

After running the Oriented Start-up routine and properly setting the parameters, the inverter is ready to operate in the V/f mode.

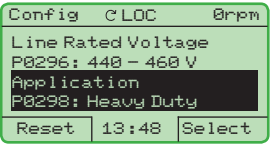
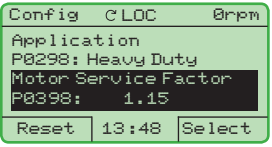
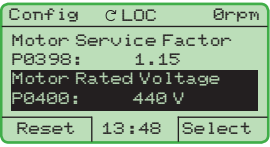
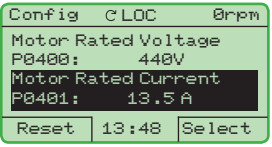
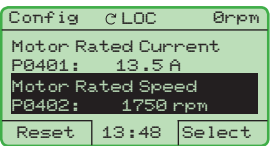
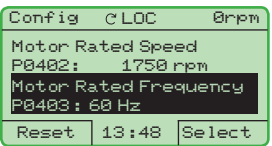
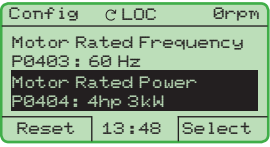
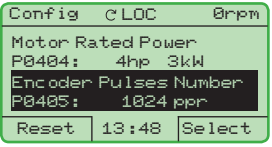
The inverter has a number of other parameters that allow its adaptation to the most different applications. This manual presents some basic parameters that shall be set in most cases. There is a group named "Basic Application" to make this task easier. A summary of the parameters inside this group is listed in Table 5.1 on page 5-7. There is also a group of read only parameters that shows the value of the most important inverter variables such as voltage, current, etc. The main parameters comprised in this group are listed in Table 5.2 on page 5-8. For further details, please refer to the CFW-11 programming manual.

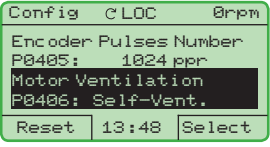
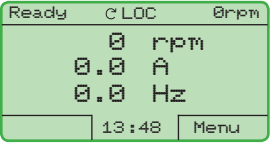
First Time Power-Up and Start-Up

Follow steps outlined in [Figure 5.3 on page 5-6](#) to set the parameters of the Basic Application group.

The procedure for start-up in the V/f operation mode is finished after setting these parameters.

Step	Action/Result	Display Indication	Step	Action/Result	Display Indication
1	- Monitoring mode - Press " Menu " (right soft key)	Ready C LOC 0rpm 0 rpm 0.0 A 0.0 Hz 15:45 Menu	2	- Group " 00 ALL PARAMETERS " has been already selected	Ready C LOC 0rpm 00 ALL PARAMETERS 01 PARAMETER GROUPS 02 ORIENTED START-UP 03 CHANGED PARAMETERS Return 15:45 Select
3	- Group " 01 PARAMETER GROUPS " is then selected	Ready C LOC 0rpm 00 ALL PARAMETERS 01 PARAMETER GROUPS 02 ORIENTED START-UP 03 CHANGED PARAMETERS Return 15:45 Select	4	- Group " 02 ORIENTED START-UP " is then selected	Ready C LOC 0rpm 00 ALL PARAMETERS 01 PARAMETER GROUPS 02 ORIENTED START-UP 03 CHANGED PARAMETERS Return 15:45 Select
5	- Group " 03 CHANGED PARAMETERS " is selected	Ready C LOC 0rpm 00 ALL PARAMETERS 01 PARAMETER GROUPS 02 ORIENTED START-UP 03 CHANGED PARAMETERS Return 15:45 Select	6	- Group " 04 BASIC APPLICATION " is selected - Press " Select "	Ready C LOC 0rpm 01 PARAMETER GROUPS 02 ORIENTED START-UP 03 CHANGED PARAMETERS 04 BASIC APPLICATION Return 15:45 Select
7	- Parameter " Acceleration Time P0100: 20.0 s " has been already selected - If needed, set P0100 according to the desired acceleration time. To do so, press " Select " - Proceed similarly until all parameters of group " 04 BASIC APPLICATION " have been set. When finished, press " Return " (left soft key)	Ready C LOC 0rpm Acceleration Time P0100: 20.0s Deceleration Time P0101: 20.0s Return 15:45 Select	8	- Press " Return "	Ready C LOC 0rpm 01 PARAMETER GROUPS 02 ORIENTED START-UP 03 CHANGED PARAMETERS 04 BASIC APPLICATION Return 15:45 Select
9	- The display returns to the Monitoring Mode and the inverter is ready to run	Ready C LOC 0rpm 0 rpm 0.0 A 0.0 Hz 15:45 Menu			

Figure 5.3 - Setting parameters of the basic application group

Table 5.1 - Parameters comprised in the basic application group

Parameter	Name	Description	Setting Range	Factory Setting	User Setting
P0100	Acceleration Time	- Defines the time to linearly accelerate from 0 up to the maximum speed (P0134) - If set to 0.0 s, it means no acceleration ramp	0.0 to 999.0 s	20.0 s	
P0101	Deceleration Time	- Defines the time to linearly decelerate from the maximum speed (P0134) up to 0 - If set to 0.0 s, it means no deceleration ramp	0.0 to 999.0 s	20.0 s	
P0133	Minimum Speed	- Defines the minimum and maximum values of the speed reference when the drive is enabled - These values are valid for any reference source	0 to 18000 rpm	90 rpm (60 Hz motor) 75 rpm (50 Hz motor)	
P0134	Maximum Speed	 <p>0 10 V 0 20 mA 4 mA 20 mA 10 V 0 20 mA 0 20 mA 4 mA</p>		1800 rpm (60 Hz motor) 1500 rpm (50 Hz motor)	
P0135	Max. Output Current	- Avoids motor stall under torque overload condition during the acceleration or deceleration - The factory default setting is for "Ramp Hold": if the motor current exceeds the value set at P0135 during the acceleration or deceleration, the motor speed will not be increased (acceleration) or decreased (deceleration) anymore. When the motor current reaches a value below the programmed in P0135, the motor speed is again increased or decreased - Other options for the current limitation are available. Refer to the CFW-11 programming manual	$0.2 \times I_{rat-HD}$ to $2 \times I_{rat-HD}$	$1.5 \times I_{rat-HD}$	
					
P0136	Manual Torque Boost	- Operates in low speeds, modifying the output voltage x frequency curve to keep the torque constant - Compensates the voltage drop at the motor stator resistance. This function operates in low speeds increasing the inverter output voltage to keep the torque constant in the V/f mode - The optimal setting is the smallest value of P0136 that allows the motor to start satisfactorily. An excessive value will considerably increase the motor current in low speeds, and may result in a fault (F048, F051, F071, F072, F078 or F183) or alarm (A046, A047, A050 or A110) condition	0 to 9	1	
					

Table 5.2 - Main read only parameters

Parameter	Description	Setting Range
P0001	Speed Reference	0 to 18000 rpm
P0002	Motor Speed	0 to 18000 rpm
P0003	Motor Current	0.0 to 4500.0 A
P0004	DC Link Voltage (Ud)	0 to 2000 V
P0005	Motor Frequency	0.0 to 300.0 Hz
P0006	VFD Status	0 = Ready 1 = Run 2 = Undervoltage 3 = Fault 4 = Self-tuning 5 = Configuration 6 = DC-Braking 7 = STO
P0007	Motor Voltage	0 to 2000 V
P0009	Motor Torque	-1000.0 to 1000.0 %
P0010	Output Power	0.0 to 6553.5 kW
P0012	DI8 to DI1 Status	0000h to 00FFh
P0013	DO5 to DO1 Status	0000h to 001Fh
P0018	AI1 Value	-100.00 to 100.00 %
P0019	AI2 Value	-100.00 to 100.00 %
P0020	AI3 Value	-100.00 to 100.00 %
P0021	AI4 Value	-100.00 to 100.00 %
P0023	Software Version	0.00 to 655.35
P0027	Accessories Config. 1	Hexadecimal code representing the identified accessories. Refer to Chapter 7 OPTION KITS AND ACCESSORIES on page 7-1
P0028	Accessories Config. 2	
P0029	Power Hardware Config.	Hexadecimal code according to the available models and option kits. Refer to Chapter 7 OPTION KITS AND ACCESSORIES on page 7-1
P0030	IGBTs Temperature U	-20.0 to 150.0 °C (-4 °F to 302 °F)
P0031	IGBTs Temperature V	-20.0 to 150.0 °C (-4 °F to 302 °F)
P0032	IGBTs Temperature W	-20.0 to 150.0 °C (-4 °F to 302 °F)
P0033	Rectifier Temperature	-20.0 to 150.0 °C (-4 °F to 302 °F)
P0034	Internal Air Temp.	-20.0 to 150.0 °C (-4 °F to 302 °F)
P0036	Fan Heatsink Speed	0 to 15000 rpm
P0037	Motor Overload Status	0 to 100 %
P0038	Encoder Speed	0 to 65535 rpm
P0040	PID Process Variable	0.0 to 100.0 %
P0041	PID Setpoint Value	0.0 to 100.0 %
P0042	Time Powered	0 to 65535h
P0043	Time Enabled	0.0 to 6553.5h
P0044	kWh Output Energy	0 to 65535 kWh
P0045	Fan Enabled Time	0 to 65535h
P0048	Present Alarm	0 to 999
P0049	Present Fault	0 to 999

Parameter	Description	Setting Range
P0050	Last Fault	0 to 999
P0051	Last Fault Day/Month	00/00 to 31/12
P0052	Last Fault Year	00 to 99
P0053	Last Fault Time	00:00 to 23:59
P0054	Second Fault	0 to 999
P0055	Second Flt. Day/Month	00/00 to 31/12
P0056	Second Fault Year	00 to 99
P0057	Second Fault Time	00:00 to 23:59
P0058	Third Fault	0 to 999
P0059	Third Fault Day/Month	00/00 to 31/12
P0060	Third Fault Year	00 to 99
P0061	Third Fault Time	00:00 to 23:59
P0062	Fourth Fault	0 to 999
P0063	Fourth Flt. Day/Month	00/00 to 31/12
P0064	Fourth Fault Year	00 to 99
P0065	Fourth Fault Time	00:00 to 23:59
P0066	Fifth Fault	0 to 999
P0067	Fifth Fault Day/Month	00/00 to 31/12
P0068	Fifth Fault Year	00 to 99
P0069	Fifth Fault Time	00:00 to 23:59
P0070	Sixth Fault	0 to 999
P0071	Sixth Fault Day/Month	00/00 to 31/12
P0072	Sixth Fault Year	00 to 99
P0073	Sixth Fault Time	00:00 to 23:59
P0074	Seventh Fault	0 to 999
P0075	Seventh Flt.Day/Month	00/00 to 31/12
P0076	Seventh Fault Year	00 to 99
P0077	Seventh Fault Time	00:00 to 23:59
P0078	Eighth Fault	0 to 999
P0079	Eighth Flt. Day/Month	00/00 to 31/12
P0080	Eighth Fault Year	00 to 99
P0081	Eighth Fault Time	00:00 to 23:59
P0082	Ninth Fault	0 to 999
P0083	Ninth Fault Day/Month	00/00 to 31/12
P0084	Ninth Fault Year	00 to 99
P0085	Ninth Fault Time	00:00 to 23:59
P0086	Tenth Fault	0 to 999
P0087	Tenth Fault Day/Month	00/00 to 31/12
P0088	Tenth Fault Year	00 to 99
P0089	Tenth Fault Time	00:00 to 23:59
P0090	Current At Last Fault	0.0 to 4000.0 A
P0091	DC Link At Last Fault	0 to 2000 V
P0092	Speed At Last Fault	0 to 18000 rpm
P0093	Reference Last Fault	0 to 18000 rpm
P0094	Frequency Last Fault	0.0 to 300.0 Hz
P0095	Motor Volt.Last Fault	0 to 2000 V
P0096	Dlx Status Last Fault	0000h to 00FFh
P0097	DOx Status Last Fault	0000h to 001Fh

5.3 SETTING DATE AND TIME

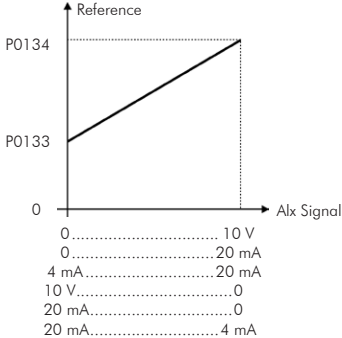
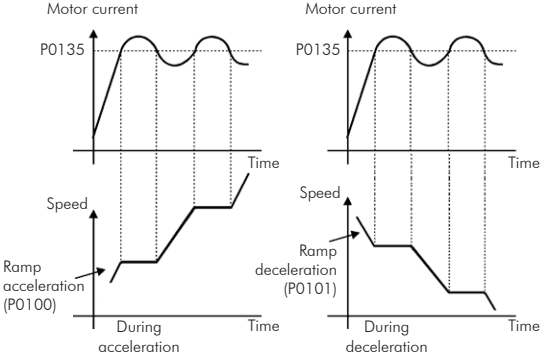
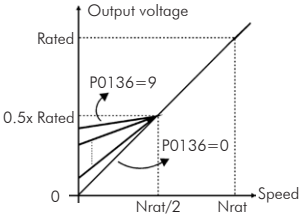



Step	Action/Result	Display Indication
1	Monitoring mode - Press "Menu" (right soft key)	Ready C LOC 0rpm 0 rpm 0.0 A 0.0 Hz 16:10 Menu
2	- Group "00 ALL PARAMETERS" is already selected 	Ready C LOC 0rpm 00 ALL PARAMETERS 01 PARAMETER GROUPS 02 ORIENTED START-UP 03 CHANGED PARAMETERS Return 16:10 Select
3	- Group "01 PARAMETER GROUPS" is selected - Press "Select"	Ready C LOC 0rpm 00 ALL PARAMETERS 01 PARAMETER GROUPS 02 ORIENTED START-UP 03 CHANGED PARAMETERS Return 16:10 Select
4	- A new list of groups is displayed and group "20 Ramps" is selected - Press  until you reach group "30 HMI"	Ready C LOC 0rpm 20 Ramps 21 Speed References 22 Speed Limits 23 V/F Control Return 16:10 Select
5	- Group "30 HMI" is selected - Press "Select"	Ready C LOC 0rpm 27 V/F DC Volt. Limit. 28 Dynamic Braking 29 Vector Control 30 HMI Return 16:10 Select
6	- Parameter "Day P0194" is already selected - If needed, set P0194 according to the actual day. To do so, press "Select" and then,  or  to change P0194 value - Follow the same steps to set parameters "Month P0195" to "Seconds P0199"	Ready C LOC 0rpm Day P0194: 06 Month P0195: 10 Return 16:10 Select
7	- Once the setting of P0199 is over, the Real Time Clock is now updated - Press "Return" (left soft key)	Ready C LOC 0rpm Minutes P0198: 11 Seconds P0199: 34 Return 18:11 Select
8	- Press "Return"	Ready C LOC 0rpm 27 V/F DC Volt. Limit. 28 Dynamic Braking 29 Vector Control 30 HMI Return 18:11 Select
9	- Press "Return"	Ready C LOC 0rpm 00 ALL PARAMETERS 01 PARAMETER GROUPS 02 ORIENTED START-UP 03 CHANGED PARAMETERS Return 18:11 Select
10	- The display is back to the monitoring mode	Ready C LOC 0rpm 0 rpm 0.0 A 0.0 Hz 18:11 Menu

Figure 5.4 - Setting date and time

5.4 BLOCKING PARAMETERS MODIFICATION

To prevent unauthorized or unintended parameters modification, parameter P0000 should be set to a value different from 5. Follow the same procedures described in [Item 5.2.1 Password Setting in P0000 on page 5-3](#).

5.5 HOW TO CONNECT A PC



NOTE!

- Always use a standard host/device shielded USB cable. Unshielded cables may lead to communication errors.
- Recommended cables: Samtec:
 - USBC-AM-MB-B-B-S-1 (1 meter).
 - USBC-AM-MB-B-B-S-2 (2 meters).
 - USBC-AM-MB-B-B-S-3 (3 meters).
- The USB connection is galvanically isolated from the mains power supply and from other high voltages internal to the inverter. However, the USB connection is not isolated from the Protective Ground (PE). Use an isolated notebook for the USB connection or a desktop connected to the same Protective Ground (PE) of the inverter.

Install the SuperDrive G2 software to control motor speed, view, or edit inverter parameters through a personal computer (PC).

Basic procedures for transferring data from the PC to the inverter:

1. Install the SuperDrive G2 software in the PC.
2. Connect the PC to the inverter through a USB cable.
3. Start SuperDrive G2.
4. Choose "Open" and the files stored in the PC will be displayed.
5. Select the file.
6. Use the command "Write Parameters to the Drive".
 - All parameters are now transferred to the inverter.

For further information on SuperDrive G2 software, please refer SuperDrive manual.

5.6 FLASH MEMORY MODULE

Location as presented in [Figure 2.2 on page 2-7](#).

Features:

- Store a copy of the inverter parameters.
- Transfer parameters stored in the FLASH memory to the inverter.
- Transfer firmware stored in the FLASH memory to the inverter.
- Store programs created by the SoftPLC.

Whenever the inverter is powered up, this program is transferred to the RAM memory located in the inverter control board and executed.

Refer to the CFW-11 programming manual and to SoftPLC manual for further details.



ATTENTION!

Before installing or removing the FLASH memory module, disconnect the inverter power supply and wait for the complete discharge of the capacitors.

6 TROUBLESHOOTING AND MAINTENANCE

This chapter presents:

- Lists all faults and alarms that may occur.
- Indicates the possible causes of each fault and alarm.
- Lists most frequent problems and corrective actions.
- Presents instructions for periodic inspections and preventive maintenance in the equipment.

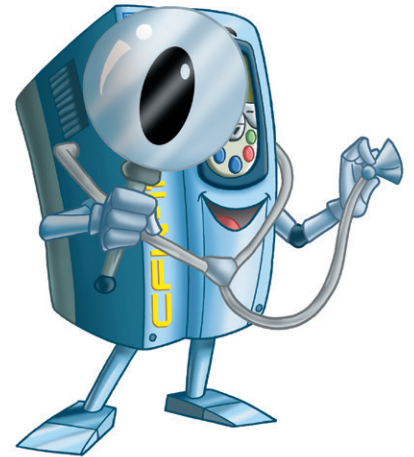

6.1 OPERATION OF THE FAULTS AND ALARMS

When a fault is detected (FXXX):

- The PWM pulses are blocked.
- The keypad displays the "FAULT" code and description.
- The "STATUS" LED starts flashing red.
- The output relay set to "NO FAULT" opens.
- Some control circuitry data is saved in the EEPROM memory:
 - HMI and EP (Electronic Pot) speed references, in case the function "Reference backup" is enabled in P0120.
 - The "FAULT" code that occurred (shifts the last nine previous faults and alarms).
 - The state of the motor overload function integrator.
 - The state of the operating hours counter (P0043) and the powered-up hours counter (P0042).

Reset the inverter to return the drive to a "READY" condition in the event of a "FAULT". The following reset options are available:

- Removing the power supply and reapplying it (power-on reset).
- Pressing the operator key  (manual reset).
- Through the "Reset" soft key.
- Automatically by setting P0206 (auto-reset).
- Through a digital input: DIx = 20 (P0263 to P0270).

When an alarm situation ("ALARM" (AXXX)) is detected:

- ☑ The keypad displays the "ALARM" code and description.
- ☑ The "STATUS" LED changes to yellow.
- ☑ The PWM pulses are not blocked (the inverter is still operating).

6.2 FAULTS, ALARMS, AND POSSIBLE CAUSES

Table 6.1 - Faults, alarms and possible causes

Fault/Alarm	Description	Possible Causes
F006 Imbalance or Input Phase Loss	Mains voltage imbalance too high or phase missing in the input power supply. Note: - If the motor is unloaded or operating with reduced load this fault may not occur. - Fault delay is set at parameter P0357. P0357 = 0 disables the fault.	<ul style="list-style-type: none"> ☑ Phase missing at the inverter's input power supply. ☑ Input voltage imbalance > 5 %.
A010 Rectifier High Temperature	A high temperature alarm was detected by the NTC temperature sensors located in the rectifier modules. Note: - This is valid only for the following models: CFW110086T2, CFW110105T2, CFW110045T4, CFW110058T4, CFW110070T4 and CFW110088T4. - It may be disabled by setting P0353 = 2 or 3.	<ul style="list-style-type: none"> ☑ Surrounding air temperature is too high (>50 °C (122 °F)) and output current is too high. ☑ Blocked or defective fan. ☑ Inverter heatsink is completely covered with dust.
F011 Rectifier Overtemperature	An overtemperature fault was detected by the NTC temperature sensors located in the rectifier modules. Note: - This is valid only for the following models: CFW110086T2, CFW110105T2, CFW110045T4, CFW110058T4, CFW110070T4 and CFW110088T4.	
F021 DC Link Undervoltage	DC Link undervoltage condition occurred.	<ul style="list-style-type: none"> ☑ The input voltage is too low and the DC Link voltage dropped below the minimum permitted value (monitor the value at parameter P0004): Ud < 223 V - for a 200 / 240 V three-phase input voltage Ud < 170 V - for a 200 / 240 V single-phase input voltage (models CFW11XXXXS2 or CFW11XXXXB2) (P0296 = 0). Ud < 385 V - for a 380 V input voltage (P0296 = 1). Ud < 405 V - for a 400 / 415 V input voltage (P0296 = 2). Ud < 446 V - for a 440 / 460 V input voltage (P0296 = 3). Ud < 487 V - for a 480 V input voltage (P0296 = 4). ☑ Phase loss in the input power supply. ☑ Pre-charge circuit failure. ☑ Parameter P0296 was set to a value above of the power supply rated voltage.
F022 DC Link Overvoltage	DC Link overvoltage condition occurred.	<ul style="list-style-type: none"> ☑ The input voltage is too high and the DC Link voltage surpassed the maximum permitted value: Ud > 400 V - for 220 / 230 V input models (P0296 = 0). Ud > 800 V - for 380 / 480 V input models (P0296 = 1, 2, 3, or 4). ☑ Inertia of the driven-load is too high or deceleration time is too short. ☑ Wrong settings for parameters P0151, or P0153, or P0185.
F030 Power Module U Fault	Desaturation of IGBT occurred in power module U. Note: This protection is available only for frame size D models.	☑ Short-circuit between motor phases U and V or U and W.
F034 Power Module V Fault	Desaturation of IGBT occurred in power module V. Note: This protection is available only for frame size D models.	☑ Short-circuit between motor phases V and U or V and W.

Fault/Alarm	Description	Possible Causes
F038 Power Module W Fault	Desaturation of IGBT occurred in power module W. Note: This protection is available only for frame size D models.	<input checked="" type="checkbox"/> Short-circuit between motor phases W and U or W and V.
F042 DB IGBT Fault	Desaturation of dynamic braking IGBT occurred. Note: This protection is available only for frame size D models.	<input checked="" type="checkbox"/> Short-circuit between the connection cables of the dynamic braking resistor.
A046 High Load on Motor	Load is too high for the used motor. Note: It may be disabled by setting P0348 = 0 or 2.	<input checked="" type="checkbox"/> Settings of P0156, P0157, and P0158 are too low for the used motor. <input checked="" type="checkbox"/> Motor shaft load is excessive.
A047 IGBT Overload Alarm	An IGBT overload alarm occurred. Note: It may be disabled by setting P0350 = 0 or 2.	<input checked="" type="checkbox"/> Inverter output current is too high.
F048 IGBT Overload Fault	An IGBT overload fault occurred. Note: It may be disabled by setting P0350 = 0 or 2.	<input checked="" type="checkbox"/> Inverter output current is too high.
A050 IGBT High Temperature	A high temperature alarm was detected by the NTC temperature sensors located on the IGBTs. Note: It may be disabled by setting P0353 = 2 or 3.	<input checked="" type="checkbox"/> Surrounding air temperature is too high (>50 °C (122 °F)) and output current is too high. <input checked="" type="checkbox"/> Blocked or defective fan. <input checked="" type="checkbox"/> Very dirty heatsink.
F051 IGBT Overtemperature	A high temperature fault was detected by the NTC temperature sensors located on the IGBTs.	
F065 Encoder Signal Fault (SW)	Feedback obtained via encoder does not match the commanded speed. The fault can be disabled via parameter P0358.	<input checked="" type="checkbox"/> Wiring between encoder and encoder interface accessory interrupted. <input checked="" type="checkbox"/> Encoder is defective. <input checked="" type="checkbox"/> Encoder coupling to the motor is broken. <input checked="" type="checkbox"/> Inverter operating in current limit (In case the application needs to run in such condition, this fault should be disabled via parameter P0358).
F066 Encoder Signal Fault (SW)	Feedback obtained via encoder does not match the commanded speed. The fault can be disabled via parameter P0358.	<input checked="" type="checkbox"/> Wiring between encoder and encoder interface accessory interrupted. <input checked="" type="checkbox"/> Encoder is defective. <input checked="" type="checkbox"/> Encoder coupling to the motor is broken. <input checked="" type="checkbox"/> Inverter operating in current limit (In case the application needs to run in such condition, this fault should be disabled via parameter P0358).
F067 Incorrect Encoder/ Motor Wiring	Fault related to the phase relation of the encoder signals, if P0202 = 4 and P0408 = 0, 2, 3 or 4. Note: - It is not possible to reset this fault (when P0408 > 1). - In this case, turn off the power supply, solve the problem, and then turn it on again. - When P0408 = 0, it is possible to reset this fault. This fault could be disabled by means of parameter P0358. In this case it is possible to reset this fault.	<input checked="" type="checkbox"/> Output motor cables U, V, W are inverted. <input checked="" type="checkbox"/> Encoder channels A and B are inverted. <input checked="" type="checkbox"/> Encoder was not properly mounted. <input checked="" type="checkbox"/> Motor with locked rotor or dragging at the start.
F070 Overcurrent/ Short-circuit	Overcurrent or short-circuit detected at the output, in the DC Link, or at the braking resistor. Note: It is available only for models of frame sizes A, B, and C.	<input checked="" type="checkbox"/> Short-circuit between two motor phases. <input checked="" type="checkbox"/> Short-circuit between the connection cables of the dynamic braking resistor. <input checked="" type="checkbox"/> IGBT modules are shorted.
F071 Output Overcurrent	The inverter output current was too high for too long.	<input checked="" type="checkbox"/> Excessive load inertia or acceleration time too short. <input checked="" type="checkbox"/> Settings of P0135, P0169 and P0170 are too high.
F072 Motor Overload	The motor overload protection operated. Note: It may be disabled by setting P0348 = 0 or 3.	<input checked="" type="checkbox"/> Settings of P0156, P0157, and P0158 are too low for the used motor. <input checked="" type="checkbox"/> Motor shaft load is excessive.
F074 Ground Fault	A ground fault occurred either in the cable between the inverter and the motor or in the motor itself. Note: It may be disabled by setting P0343 = 0.	<input checked="" type="checkbox"/> Shorted wiring in one or more of the output phases. <input checked="" type="checkbox"/> Motor cable capacitance is too large, resulting in current peaks at the output. ⁽¹⁾
F076 Motor Current Imbalance	Fault of motor current imbalance. Note: It may be disabled by setting P0342 = 0.	<input checked="" type="checkbox"/> Loose connection or broken wiring between the motor and inverter connection. <input checked="" type="checkbox"/> Vector control with wrong orientation. <input checked="" type="checkbox"/> Vector control with encoder, encoder wiring or encoder motor connection inverted.

Fault/Alarm	Description	Possible Causes
F077 DB Resistor Overload	The dynamic braking resistor overload protection operated.	<ul style="list-style-type: none"> <input checked="" type="checkbox"/> Excessive load inertia or desacceleration time too short. <input checked="" type="checkbox"/> Motor shaft load is excessive. <input checked="" type="checkbox"/> Wrong settings for parameters P0154 and P0155.
F078 Motor Overtemperature	Fault related to the PTC temperature sensor installed in the motor. Note: - It may be disabled by setting P0351 = 0 or 3. - It is required to set the analog input/output to the PTC function.	<ul style="list-style-type: none"> <input checked="" type="checkbox"/> Excessive load at the motor shaft. <input checked="" type="checkbox"/> Excessive duty cycle (too many starts/stops per minute). <input checked="" type="checkbox"/> Surrounding air temperature too high. <input checked="" type="checkbox"/> Loose connection or short-circuit (resistance < 100 Ω) in the wiring connected to the motor termistor. <input checked="" type="checkbox"/> Motor termistor is not installed. <input checked="" type="checkbox"/> Blocked motor shaft.
F079 Encoder Signal Fault	Lack of encoder signals. The fault can be disabled via switches of the ENC1, ENC2 board.	<ul style="list-style-type: none"> <input checked="" type="checkbox"/> Broken wiring between motor encoder and option kit for encoder interface. <input checked="" type="checkbox"/> Defective encoder. <input checked="" type="checkbox"/> Encoder accessory defective or not well installed on the product, and control configured for vector with encoder.
F080 CPU Watchdog	Microcontroller watchdog fault.	<ul style="list-style-type: none"> <input checked="" type="checkbox"/> Electrical noise.
F082 Copy Function Fault	Fault while copying parameters.	<ul style="list-style-type: none"> <input checked="" type="checkbox"/> Communication problem with the HMI.
F084 Auto-diagnosis Fault	Auto-diagnosis fault.	<ul style="list-style-type: none"> <input checked="" type="checkbox"/> Defect in the inverter internal circuitry.
A088 Communication Lost	Indicates a problem between the keypad and control board communication.	<ul style="list-style-type: none"> <input checked="" type="checkbox"/> Loose keypad cable connection. <input checked="" type="checkbox"/> Electrical noise in the installation.
A090 External Alarm	External alarm via digital input. Note: It is required to set a digital input to "No external alarm".	<ul style="list-style-type: none"> <input checked="" type="checkbox"/> Wiring was not connected to the digital input (DI1 to DI8) set to "No external alarm".
F091 External Fault	External fault via digital input. Note: It is required to set a digital input to "No external fault".	<ul style="list-style-type: none"> <input checked="" type="checkbox"/> Wiring was not connected to the digital input (DI1 to DI8) set to "No external fault".
F099 Invalid Current Offset	Current measurement circuit is measuring a wrong value for null current.	<ul style="list-style-type: none"> <input checked="" type="checkbox"/> Defect in the inverter internal circuitry.
A110 High Motor Temperature	Alarm related to the PTC temperature sensor installed in the motor. Note: - It may be disabled by setting P0351 = 0 or 2. - It is required to set the analog input/output to the PTC function.	<ul style="list-style-type: none"> <input checked="" type="checkbox"/> Excessive load at the motor shaft. <input checked="" type="checkbox"/> Excessive duty cycle (too many starts/stops per minute). <input checked="" type="checkbox"/> Surrounding air temperature too high. <input checked="" type="checkbox"/> Loose connection or short-circuit (resistance < 100 Ω) in the wiring connected to the motor termistor. <input checked="" type="checkbox"/> Motor termistor is not installed. <input checked="" type="checkbox"/> Blocked motor shaft.
A128 Timeout for Serial Communication	Indicates that the inverter stopped receiving valid messages within a certain time interval. Note: It may be disabled by setting P0314 = 0.0 s.	<ul style="list-style-type: none"> <input checked="" type="checkbox"/> Check the wiring and grounding installation. <input checked="" type="checkbox"/> Make sure the inverter has sent a new message within the time interval set at P0314.
A129 Anybus is Offline	Alarm that indicates interruption of the Anybus-CC communication.	<ul style="list-style-type: none"> <input checked="" type="checkbox"/> PLC entered into the idle state. <input checked="" type="checkbox"/> Programming error. Master and slave set with a different number of I/O words. <input checked="" type="checkbox"/> Communication with master has been lost (broken cable, unplugged connector, etc.).
A130 Anybus Access Error	Alarm that indicates an access error to the Anybus-CC communication module.	<ul style="list-style-type: none"> <input checked="" type="checkbox"/> Defective, unrecognized, or improperly installed Anybus-CC module. <input checked="" type="checkbox"/> Conflict with a WEG option board.
A133 CAN Not Powered	Alarm indicating that the power supply was not connected to the CAN controller.	<ul style="list-style-type: none"> <input checked="" type="checkbox"/> Broken or loose cable. <input checked="" type="checkbox"/> Power supply is off.
A134 Bus Off	Inverter CAN interface has entered into the bus-off state.	<ul style="list-style-type: none"> <input checked="" type="checkbox"/> Incorrect communication baud-rate. <input checked="" type="checkbox"/> Two nodes configured with the same address in the network. <input checked="" type="checkbox"/> Wrong cable connection (inverted signals).
A135 CANopen Communication Error	Alarm that indicates a communication error.	<ul style="list-style-type: none"> <input checked="" type="checkbox"/> Communication problems. <input checked="" type="checkbox"/> Wrong master configuration/settings. <input checked="" type="checkbox"/> Incorrect configuration of the communication objects.
A136 Idle Master	Network master has entered into the idle state.	<ul style="list-style-type: none"> <input checked="" type="checkbox"/> PLC in IDLE mode. <input checked="" type="checkbox"/> Bit of the PLC command register set to zero (0).
A137 DNet Connection Timeout	I/O connection timeout - DeviceNet communication alarm.	<ul style="list-style-type: none"> <input checked="" type="checkbox"/> One or more allocated I/O connections have entered into the timeout state.

Fault/Alarm	Description	Possible Causes
A138⁽³⁾ Profibus DP Interface in Clear Mode	It indicates that the inverter received a command from the Profibus DP network master to enter the clear mode.	<ul style="list-style-type: none"> <input checked="" type="checkbox"/> Verify the network master status, making sure it is in execution mode (Run). <input checked="" type="checkbox"/> Refer to the Profibus DP communication manual for more information.
A139⁽³⁾ Offline Profibus DP Interface	It indicates an interruption in the communication between the Profibus DP network master and the inverter.	<ul style="list-style-type: none"> <input checked="" type="checkbox"/> Verify whether the network master is correctly configured and operating normally. <input checked="" type="checkbox"/> Verify the network installation in a general manner – cable routing, grounding. <input checked="" type="checkbox"/> Refer to the Profibus DP communication manual for more information.
A140⁽³⁾ Profibus DP Module Access Error	It indicates an error in the access to the Profibus DP communication module data.	<ul style="list-style-type: none"> <input checked="" type="checkbox"/> Verify whether the Profibus DP module is correctly fit into the slot 3. <input checked="" type="checkbox"/> Refer to the Profibus DP communication manual for more information.
F150 Motor Overspeed	Overspeed fault. It is activated when the real speed exceeds the value of P0134+P0132 for more than 20 ms.	<ul style="list-style-type: none"> <input checked="" type="checkbox"/> Wrong settings of P0161 and/or P0162. <input checked="" type="checkbox"/> Problem with the hoist-type load.
F151 FLASH Memory Module Fault	FLASH Memory Module fault (MMF-03).	<ul style="list-style-type: none"> <input checked="" type="checkbox"/> Defective FLASH memory module. <input checked="" type="checkbox"/> Check the connection of the FLASH memory module.
A152 Internal Air High Temperature	Alarm indicating that the internal air temperature is too high. Note: It may be disabled by setting P0353 = 1 or 3.	<ul style="list-style-type: none"> <input checked="" type="checkbox"/> Surrounding air temperature too high (>50 °C (122 °F)) and excessive output current. <input checked="" type="checkbox"/> Defective internal fan (if installed).
F153 Internal Air Overtemperature	Internal air overtemperature fault.	
F156 Undertemperature	Undertemperature fault (below -30 °C (-22 °F)) in the IGBT or rectifier measured by the temperature sensors.	<ul style="list-style-type: none"> <input checked="" type="checkbox"/> Surrounding air temperature ≤ -30 °C (-22 °F).
F160 Safety Stop Relays	Safety Stop relay fault.	<ul style="list-style-type: none"> <input checked="" type="checkbox"/> It was only applied +24 Vdc to one STO input (STO1 or STO2). <input checked="" type="checkbox"/> One of the relays is defective.
F161 Timeout PLC11 CFW-11	<ul style="list-style-type: none"> <input checked="" type="checkbox"/> Refer to the PLC11-01 module programming manual. 	
A162 Incompatible PLC Firmware		
A163 Break Detect AI1	It indicates that the AI1 current (4-20 mA or 20-4 mA) reference is out of the 4 to 20 mA range.	<ul style="list-style-type: none"> <input checked="" type="checkbox"/> Broken AI1 cable. <input checked="" type="checkbox"/> Bad contact at the signal connection to the terminal strip.
A164 Break Detect AI2	It indicates that the AI2 current (4-20 mA or 20-4 mA) reference is out of the 4 to 20 mA range.	<ul style="list-style-type: none"> <input checked="" type="checkbox"/> Broken AI2 cable. <input checked="" type="checkbox"/> Bad contact at the signal connection to the terminal strip.
A165 Break Detect AI3	It indicates that the AI3 current (4-20 mA or 20-4 mA) reference is out of the 4 to 20 mA range.	<ul style="list-style-type: none"> <input checked="" type="checkbox"/> Broken AI3 cable. <input checked="" type="checkbox"/> Bad contact at the signal connection to the terminal strip.
A166 Break Detect AI4	It indicates that the AI4 current (4-20 mA or 20-4 mA) reference is out of the 4 to 20 mA range.	<ul style="list-style-type: none"> <input checked="" type="checkbox"/> Broken AI4 cable. <input checked="" type="checkbox"/> Bad contact at the signal connection to the terminal strip.
A177 Fan Replacement	Heatsink fan replacement alarm (P0045 > 50000 hours). Note: This function may be disabled by setting P0354 = 0.	<ul style="list-style-type: none"> <input checked="" type="checkbox"/> Maximum number of operating hours for the heatsink fan has been reached.
A178 Fan Speed Alarm	Alarm referring to the fan speed of the heatsink.	<ul style="list-style-type: none"> <input checked="" type="checkbox"/> Dirt on the blades and rolling bearings of the fan. <input checked="" type="checkbox"/> Defective fan. <input checked="" type="checkbox"/> Defective connection of the fan power supply.
F179 Heatsink Fan Speed Fault	This fault indicates a problem with the heatsink fan. Note: This function may be disabled by setting P0354 = 0.	<ul style="list-style-type: none"> <input checked="" type="checkbox"/> Dirt on the blades and in the bearings of the fan. <input checked="" type="checkbox"/> Defective fan.
A181 Invalid Clock Value	Invalid clock value alarm.	<ul style="list-style-type: none"> <input checked="" type="checkbox"/> It is necessary to set date and time at parameters P0194 to P0199. <input checked="" type="checkbox"/> Keypad battery is discharged, defective, or not installed.
F182 Pulse Feedback Fault	Indicates a fault on the output pulses feedback.	<ul style="list-style-type: none"> <input checked="" type="checkbox"/> No motor connected or the motor connected to the inverter output is too small. <input checked="" type="checkbox"/> Possible defect on the internal circuits of the inverter. Possible solutions: <input checked="" type="checkbox"/> Reset inverter and try again. <input checked="" type="checkbox"/> Set P0356 = 0 and try again.

Fault/Alarm	Description	Possible Causes
F183 IGBTs Overload + Temperature	Overtemperature related to the IGBTs overload protection.	<input checked="" type="checkbox"/> Surrounding air temperature too high. <input checked="" type="checkbox"/> Operation with frequencies < 10 Hz under overload.
F186 (2) Sensor 1 Temperature Fault	It indicates a temperature fault at the sensor 1.	<input checked="" type="checkbox"/> Motor high temperature.
F187 (2) Sensor 2 Temperature Fault	It indicates a temperature fault at the sensor 2.	
F188 (2) Sensor 3 Temperature Fault	It indicates a temperature fault at the sensor 3.	
F189 (2) Sensor 4 Temperature Fault	It indicates a temperature fault at the sensor 4.	
F190 (2) Sensor 5 Temperature Fault	It indicates a temperature fault at the sensor 5.	
A191 (2) Sensor 1 Temperature Alarm	It indicates a temperature alarm at the sensor 1.	<input checked="" type="checkbox"/> Motor high temperature. <input checked="" type="checkbox"/> A problem in the wiring connecting the sensor to the IOE 01 (02 or 03).
A192 (2) Sensor 2 Temperature Alarm	It indicates a temperature alarm at the sensor 2.	
A193 (2) Sensor 3 Temperature Alarm	It indicates a temperature alarm at the sensor 3.	
A194 (2) Sensor 4 Temperature Alarm	It indicates a temperature alarm at the sensor 4.	
A195 (2) Sensor 5 Temperature Alarm	It indicates a temperature alarm at the sensor 5.	
A196 (2) Sensor 1 Cable Alarm	Sensor 1 cable alarm.	<input checked="" type="checkbox"/> Shorted temperature sensor.
A197 (2) Sensor 2 Cable Alarm	Sensor 2 cable alarm.	
A198 (2) Sensor 3 Cable Alarm	Sensor 3 cable alarm.	
A199 (2) Sensor 4 Cable Alarm	Sensor 4 cable alarm.	
A200 (2) Sensor 5 Cable Alarm	Sensor 5 cable alarm.	
F228 Serial Communication Timeout	<input checked="" type="checkbox"/> Refer to the RS-232 / RS-485 Serial communication manual.	
F229 Anybus Offline	<input checked="" type="checkbox"/> Refer to the Anybus-CC communication manual.	
F230 Anybus Access Error		
F233 CAN Bus Power Failure	<input checked="" type="checkbox"/> Refer to the CANopen communication manual and/or the DeviceNet communication manual.	
F234 Bus Off		
F235 CANopen Communication Error	<input checked="" type="checkbox"/> Refer to the CANopen communication manual.	
F236 Master Idle	<input checked="" type="checkbox"/> Refer to the DeviceNet communication manual.	
F237 DeviceNet Connect Timeout		

Fault/Alarm	Description	Possible Causes
F238 (3) Profibus DP Interface in Clear Mode	☑ Refer to the Profibus DP communication manual.	
F239 (3) Offline Profibus DP Interface		
F240 (3) Profibus DP Module Access Error		
A700 (4) Detached HMI	Alarm or fault related to the HMI disconnection.	☑ RTC function block has been activated in the applicative and the HMI is disconnected from the inverter.
F701 (4) Detached HMI		
A702 (4) Inverter Disabled	Alarm indicating that the General Enable command is not active.	☑ The SoftPLC Run/Stop command is equal to Run or a movement block has been enable while the inverter is general disabled.
A704 (4) Two Movements Enabled	Two movements have been enabled.	☑ It occurs when two or more movement blocks are enabled simultaneously.
A706 (4) Speed Reference Not Programmed for SoftPLC	Speed reference not programmed for SoftPLC.	☑ It occurs when a movement block has been enabled and the speed reference has not been configured for SoftPLC (check P0221 and P0222).

(1) Long motor cables (with more than 100 meters) will have a high leakage capacitance to the ground. The circulation of leakage currents through these capacitances may activate the ground fault protection after the inverter is enabled, and consequently, the occurrence of fault F074. Possible solutions:

- Decrease the carrier frequency (P0297).

- Install an output reactor between the inverter and the motor.

(2) With IOE-01 (02 or 03) modules connected into the slot 1 (XC41).

(3) With a Profibus DB module connected into the slot 3 (XC43).

(4) All the models with SoftPLC applicative.



NOTE!

The range from P0750 to P0799 is destined to the SoftPLC applicative user faults and alarms.

6.3 SOLUTIONS FOR THE MOST FREQUENT PROBLEMS

Table 6.2 - Solutions for the most frequent problems

Problem	Point to be Verified	Corrective Action
Motor does not start	Incorrect wiring connection	1. Check all power and control connections. For instance, the digital inputs set to Start/Stop, General Enable, or no external error shall be connected to the 24 Vdc or to DGND* terminals (refer to Figure 3.17 on page 3-29)
	Analog reference (if used)	1. Check if the external signal is properly connected 2. Check the status of the control potentiometer (if used)
	Incorrect settings	1. Check if parameters are properly set for the application
	Fault	1. Check if the inverter is not blocked due to a fault condition 2. Check if terminals XC1:13 and XC1:11 are not shorted (short-circuit at the 24 Vdc power supply)
	Motor stall	1. Decrease motor overload 2. Increase P0136, P0137 (V/f), or P0169/P0170 (vector control)
Motor speed fluctuates (oscillates)	Loose connection	1. Stop the inverter, turn off the power supply, and check and tighten all power connections 2. Check all internal connections of the inverter
	Defective reference potentiometer	1. Replace potentiometer
	Oscillation of the external analog reference	1. Identify the cause of the oscillation. If it is caused by electrical noise, use shielded cables or separate from the power and control wiring
	Incorrect settings (vector control)	1. Check parameters P0410, P0412, P0161, P0162, P0175, and P0176 2. Refer to the programming manual
Motor speed too high or too low	Incorrect settings (reference limits)	1. Check if the values of P0133 (minimum speed) and P0134 (maximum speed) are properly set for the motor and application used
	Control signal from the analog reference (if used)	1. Check the level of the reference control signal 2. Check the settings (gain and offset) of parameters P0232 to P0249
	Motor nameplate	1. Check if the motor has been properly sized for the application
Motor does not operate in the field weakening region (Vector Control)	Settings	1. Decrease P0180 2. Check P0410
Off display	Keypad connections	1. Check the inverter keypad connection
	Power supply voltage	1. Rated values shall be within the limits specified below: 200-230 V power supply: - Min: 187 V - Max: 253 V 380-480 V power supply: - Min: 323 V - Max: 528 V
	Blown fuses	1. Replace fuses
Low motor speed and P0009 = P0169 or P0170 (motor operating with torque limitation), for P0202 = 4 - vector with encoder	Encoder signals are inverted or power connection is inverted	1. Check signals $A - \bar{A}$, $B - \bar{B}$, refer to the incremental encoder (ENC -01 and ENC-02) interface manual. If signals are properly installed, exchange two of the output phases. For instance U and V

6.4 INFORMATION FOR CONTACTING TECHNICAL SUPPORT



NOTE!

For technical support and servicing, it is important to have the following information in hand:

- ☑ Inverter model.
- ☑ Serial number, manufacturing date, and hardware revision that are listed in the product nameplate (refer to [Section 2.4 IDENTIFICATION LABELS FOR THE CFW-11 on page 2-8](#)).
- ☑ Installed software version (check parameter P0023).
- ☑ Application data and inverter settings.

6.5 PREVENTIVE MAINTENANCE



DANGER!

- ☑ Always turn off the mains power supply before touching any electrical component associated to the inverter.
- ☑ High voltage may still be present even after disconnecting the power supply.
- ☑ To prevent electric shock, wait at least 10 minutes after turning off the input power for the complete discharge of the power capacitors.
- ☑ Always connect the equipment frame to the protective ground (PE). Use the adequate connection terminal in the inverter.



DANGER!

- ☑ Débranchez toujours l'alimentation principale avant d'entrer en contact avec un appareil électrique associé au variateur.
- ☑ Des tensions élevées peuvent encore être présentes, même après déconnexion de l'alimentation.
- ☑ Pour éviter les risques d'électrocution, attendre au moins 10 minutes après avoir coupé l'alimentation d'entrée pour que les condensateurs de puissance soient totalement déchargés.
- ☑ Raccordez toujours la masse de l'appareil à une terre protectrice (PE). Utiliser la borne de connexion adéquate du variateur.



ATTENTION!

The electronic boards have electrostatic discharge sensitive components. Do not touch the components or connectors directly. If needed, first touch the grounded metallic frame or wear a ground strap.

**Do not perform any withstand voltage test!
If needed, consult WEG.**

The inverters require low maintenance when properly installed and operated. [Table 6.3 on page 6-9](#) presents main procedures and time intervals for preventive maintenance. [Table 6.4 on page 6-10](#) provides recommended periodic inspections to be performed every 6 months after inverter start-up.

Table 6.3 - Preventive maintenance

Maintenance		Interval	Instructions
Fan replacement		After 50.000 operating hours ⁽¹⁾	Replacement procedure shown in Figure 6.1 on page 6-11 and Figure 6.2 on page 6-11
Keypad battery replacement		Every 10 years	Refer to Chapter 4 HMI on page 4-1
Electrolytic capacitors	If the inverter is stocked (not being used): "Reforming"	Every year from the manufacturing date printed in the inverter identification label (refer to Section 2.4 IDENTIFICATION LABELS FOR THE CFW-11 on page 2-8)	Apply power to the inverter (voltage between 200 and 230 Vac, single-phase or three-phase, 50 or 60 Hz) for at least one hour. Then, disconnect the power supply and wait at least 24 hours before using the inverter (reapply power)
	Inverter is being used: replace	Every 10 years	Contact WEG technical support

(1) The inverters are set at the factory for automatic fan control (P0352 = 2), which means that they will be turned on only when the heatsink temperature exceeds a reference value. Therefore, the operating hours of the fan will depend on the inverter usage conditions (motor current, output frequency, cooling air temperature, etc.). The inverter stores the number of fan operating hours in the parameter P0045. When this parameter reaches 50000 operating hours, the keypad display shows the alarm A177.

Table 6.4 - Recommended periodic inspections - Every 6 months

Component	Problem	Corrective Action
Terminals, connectors	Loose screws	Tighten
	Loose connectors	
Fans / Cooling system	Dirty fans	Cleaning
	Abnormal acoustic noise	Replace fan. Refer to Figure 6.1 on page 6-11 for the removal of the fan. Install the new fan in the reverse sequence of the removal
	Blocked fan	
	Abnormal vibration	
	Dust in the cabinet air filter	Cleaning or replacement.
Printed circuit boards	Accumulation of dust, oil, humidity, etc.	Cleaning
	Odor	Replacement
Power module / Power connections	Accumulation of dust, oil, humidity, etc.	Cleaning
	Loose connection screws	Tighten
DC Link capacitors	Discoloration / odor / electrolyte leakage	Replacement
	Expanded or broken safety valve	
	Frame expansion	
Power resistors	Discoloration	Replacement
	Odor	
Heatsink	Dust accumulation	Cleaning
	Dirty	

6.5.1 Cleaning Instructions

If needed to clean the inverter, follow the guidelines below:

Ventilation system:

- Disconnect the inverter power supply and wait at least 10 minutes.
- Remove the dust from the cooling air inlet by using a soft brush or a flannel.
- Remove the dust from the heatsink fins and from the fan blades by using compressed air.

Electronic boards:

- Disconnect the inverter power supply and wait at least 10 minutes.
- Remove the dust from the electronic board by using an anti-static brush or an ion air gun (Charges Burtes Ion Gun - reference A6030-6DESCO).
- If needed, remove the boards from the inverter.
- Always wear a ground strap.

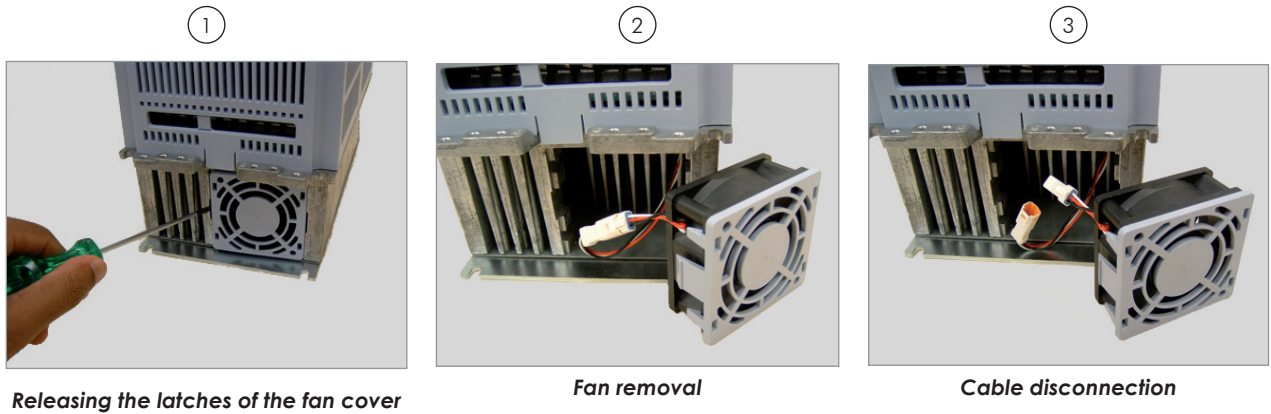

Figure 6.1 - Removing the heatsink fan

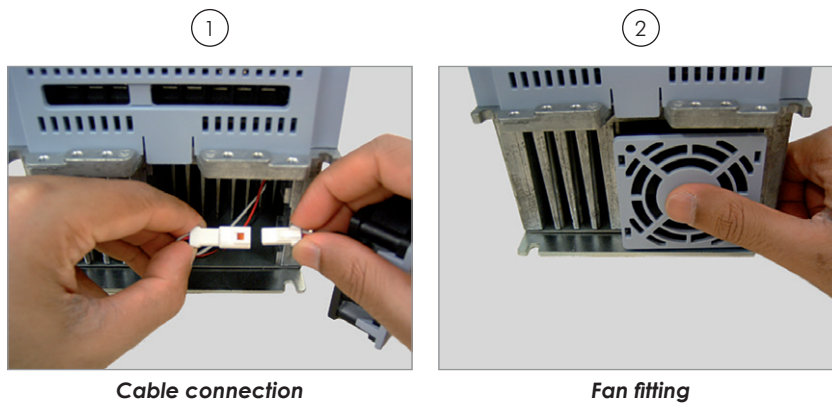

Figure 6.2 - Fan installation

7 OPTION KITS AND ACCESSORIES

This chapter presents:

- ☑ The option kits that can be incorporated to the inverter from the factory:
 - RFI filter.
 - External 24 Vdc power supply for control and HMI.
- ☑ Instructions for the proper use of the option kits.
- ☑ The accessories that can be incorporated to the inverters.



Instructions for the installation, operation, and programming of the accessories are described in their own manuals and are not present in this chapter.

7.1 OPTION KITS

Some models cannot incorporate all available option kits. Refer to [Table 8.1 on page 8-2](#) for a detailed description of the option kits that are available for each inverter model.

The inverter codification is described in [Chapter 2 GENERAL INSTRUCTIONS on page 2-1](#).

7.1.1 RFI Filter

Inverters with the following codification: CFW11XXXXXOFA. Refer to [Table 8.1 on page 8-2](#) for information on availability of this option kit for each inverter model.



ATTENTION!

Do not use inverters with internal RFI filters in IT networks (ungrounded neutral or grounding provided by a high ohm value resistor) or in grounded delta networks ("delta corner earth"). These type of installations will damage the inverter filter capacitors.

The RFI filter reduces the conducted noise of the inverter to the electrical supply system in the high frequency range (>150 kHz).

The RFI filter is required for the compliance with conducted emissions limits established by the Electromagnetic Compatibility standards such as EN 61800-3 and EN 55011.

For the proper operation of the RFI filter, please follow the instructions listed in [Section 3.4 INSTALLATION ACCORDING TO THE EUROPEAN DIRECTIVE OF ELECTROMAGNETIC COMPATIBILITY on page 3-43](#). This chapter also provides information on the compliance of these standards, such as the maximum motor cable length.

7.1.2 24 Vdc External Control Power Supply

Inverters with the following codification: CFW11XXXXXXOW.

The use of this option kit is recommended with communication networks (Profibus, DeviceNet, etc.), since the control circuit and the network communication interface are kept active (with power supply and responding to the network communication commands) even in the event of main power supply interruption.

Inverters with this option have a built-in DC/DC converter with a 24 Vdc input that provides an adequate output for the control circuit. In such manner the power supply of the control circuit will be redundant, i.e., it can be provided by a 24 Vdc external power supply (connection as shown in Figure 7.1 on page 7-2) or by the standard internal switched-mode power supply of the inverter.

Observe that the inverters with the external 24 Vdc power supply option use terminals XC1:11 and 13 as the input for the external power supply and no longer as an output as in the standard inverter (Figure 7.1 on page 7-2).

In case of interruption of the external 24 Vdc power source, the digital inputs/outputs and analog outputs will have no power supply, even if the mains power is on. Therefore, it is recommended to keep the 24 Vdc power source always connected to terminals XC1:11 and 13.

The keypad displays warnings indicating the inverter status: if the 24 Vdc power source is connected, if the mains power source is connected, etc.

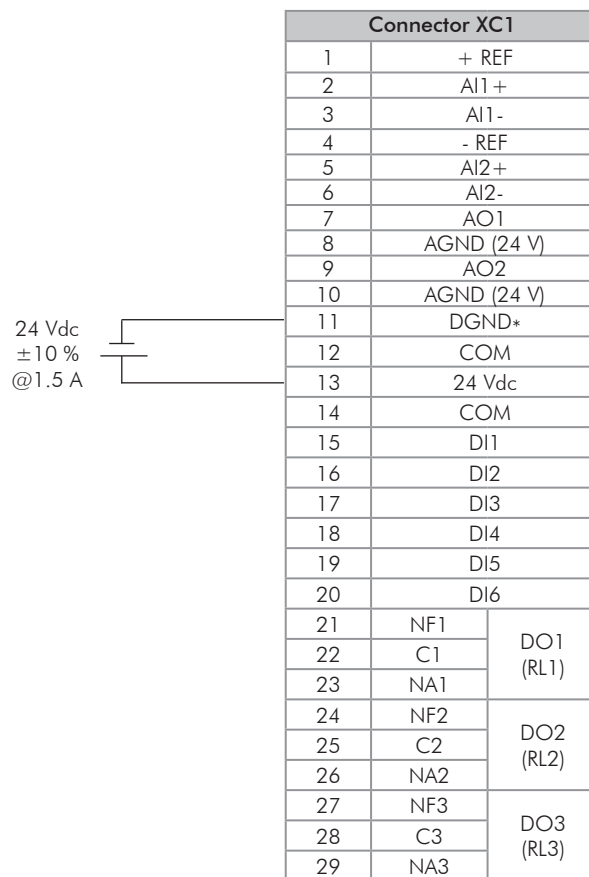

Figure 7.1 - Connection terminals and 24 Vdc external power supply rating

**NOTE!**

A class 2 power supply must be used in order to comply with the UL508C standard.

7.1.3 Nema1 Degree Protection - Frame Sizes A, B and C

Inverters with the following codification:

CFW11...ON1...

Refer to [Section 8.7 CONDUIT KIT IP21](#) on page 8-16.

7.1.4 IP21 Degree Protection

Inverters with the following codification:

CFW11...O21...

This optional item is only available on inverters of frame size D.

7.1.5 IP55 Degree Protection

Inverters with the following codification:

CFW11...O55...

Note that when this optional item is specified, the rated ambient temperature is reduced from 50 to 40 °C (122 °F to 104 °F).

7.1.6 Safety Stop Function

Inverters with the following codification CFW11...O...Y... Refer to [Section 3.3 SAFETY STOP FUNCTION](#) on page 3-35.

7.1.7 Switch-Disconnecter on the Inverter Power Supply

Inverters with the following codification:

CFW11...O55...DS...

This optional item is only available on inverters with degree of protection IP55.

7.2 ACCESSORIES

The accessories are installed to the inverter easily and quickly using the "Plug and Play" concept. Once the accessory is connected to the slot, the control circuitry identifies the model and displays the installed accessory code in P0027 or P0028. The accessory shall be installed with the inverter power supply off.

Part number and model of each available accessory are presented in [Table 7.1 on page 7-4](#). The accessories can be ordered separately and will be shipped in an individual package containing the components and the manual with detailed instructions for the product installation, operation, and programming.

**ATTENTION!**

Only one module can be fitted at once in each slot (1, 2, 3, 4, or 5).

Table 7.1 - Accessory models

WEG Part Number	Name	Description	Slot	Identification Parameters	
				P0027	P0028
Control Accessories for Installation in the Slots 1, 2 and 3					
11008162	IOA-01	IOA module: 1 voltage/current analog input (14 bits); 2 digital inputs; 2 voltage/current analog outputs (14 bits); 2 open-collector digital outputs	1	FD--	----
11008099	IOB-01	IOB module: 2 isolated analog inputs (voltage/current); 2 digital inputs; 2 isolated analog outputs (voltage/current) (the programming of the outputs is identical as in the standard CFW-11); 2 open-collector digital outputs	1	FA--	----
11126674	IOC-01	IOC module with 8 digital inputs and 4 relay outputs (use with SoffPLC)	1	C1	----
11126730	IOC-02	IOC module with 8 digital inputs and 8 NPN open collector digital outputs (use with SoffPLC)	1	C5	----
11820111	IOC-03	IOC module with 8 digital inputs and 7 PNP open collector digital outputs	1	C6	----
11126732	IOE-01	Input module with 5 PTC type sensors	1	25--	----
11126735	IOE-02	Input module with 5 PT100 type sensors	1	23--	----
11126750	IOE-03	Input module with 5 KTY84 type sensors	1	27--	----
11008100	ENC-01	5 to 12 Vdc incremental encoder module, 100 kHz, with an encoder signal repeater	2	--C2	----
11008101	ENC-02	5 to 12 Vdc incremental encoder module, 100 kHz	2	--C2	----
11008102	RS485-01	RS-485 serial communication module (Modbus)	3	----	CE--
11008103	RS232-01	RS-232C serial communication module (Modbus)	3	----	CC--
11008104	RS232-02	RS-232C serial communication module (Modbus)	3	----	CC--
11008105	CAN/RS485-01	CAN and RS-485 interface module (CANopen/DeviceNet/Modbus)	3	----	CA--
11008106	CAN-01	CAN interface module (CANopen/DeviceNet)	3	----	CD--
11045488	PROFIBUS DP-01	Profibus DP communication module	3	----	C9
11008911	PLC11-01	PLC module	1, 2 and 3	----	--xx (1) (3)
11094251	PLC11-02	PLC module			
Anybus-CC Accessories for Installation in the Slot 4					
11008158	DEVICENET-05	DeviceNet interface module	4	----	--xx (2) (3)
10933688	ETHERNET/IP-05	Ethernet/IP interface module	4	----	--xx (2) (3)
12272760	ETHERNET/IP-2p-05	EtherNet/IP-2p interface module	4	----	--xx (2) (3)
11550476	MODBUSTCP-05	Modbus TCP interface module	4	----	--xx (2) (3)
11550548	PROFINETIO-05	PROFINET IO interface module	4	----	--xx (2) (3)
11008107	PROFDP-05	Profibus DP interface module	4	----	--xx (2) (3)
11008161	RS485-05	RS-485 (passive) interface module (Modbus)	4	----	--xx (2) (3)
11008160	RS232-05	RS-232 (passive) interface module (Modbus)	4	----	--xx (2) (3)
Flash Memory Module for Installation in the Slot 5 - Factory Settings Included					
11719952	MMF-03	FLASH memory module	5	----	--xx (3)
Stand-alone HMI, Blank Cover, and Frame for Remote Mounted HMI					
11008913	HMI-01	Stand-alone HMI (4)	HMI	-	-
11010521	RHMIF-01	Remote HMI frame kit (IP65)	-	-	-
11010298	HMID-01	Blank cover for the HMI slot	HMI	-	-
10950192	HMI CAB-RS-1M	1 m serial remote keypad cable set	-	-	-
10951226	HMI CAB-RS-2M	2 m serial remote keypad cable set	-	-	-
10951223	HMI CAB-RS-3M	3 m serial remote keypad cable set	-	-	-
10951227	HMI CAB-RS-5M	4 m serial remote keypad cable set	-	-	-
10951240	HMI CAB-RS-7,5M	7.5 m serial remote keypad cable set	-	-	-
10951239	HMI CAB-RS-10M	10 m serial remote keypad cable set	-	-	-
Miscellaneous					
11010787	KN1A-01	Conduit kit for frame size A (standard for option N1) (5)	-	-	-
11010800	KN1B-01	Conduit kit for frame size B (standard for option N1) (5)	-	-	-
11010802	KN1C-01	Conduit kit for frame size C (standard for option N1) (5)	-	-	-
11010264	KIP2XD-01	IP2X kit for frame size D (standard for option 21)	-	-	-
11010265	PCSA-01	Kit for power cables shielding - frame size A (standard for option FA)	-	-	-
11010266	PCSB-01	Kit for power cables shielding - frame size B with degree protection IP2X (standard for option FA)	-	-	-
12705234	PCSB-01	Kit for power cables shielding - frame sizes B and C with degree protection IP55	-	-	-
11010267	PCSC-01	Kit for power cables shielding - frame size C with degree protection IP2X (standard for option FA)	-	-	-
11119781	PCSD-01	Kit for power cables shielding - frame size D (included in the standard product)	-	-	-
10960847	CCS-01	Control cable shielding kit (supplied with the product)	-	-	-
13429125	CFW11-KSDC-01	Kit cables and connector to disable STO valid for all models except those of frame size A with degree protection IP2X	-	-	-

(1) Refer to the PLC module manual.

(2) Refer to the Anybus-CC communication manual.

(3) Refer to the programming manual.

(4) Use DB-9 pin, male-to-female, straight-through cable (serial mouse extension type) for connecting the HMI to the inverter or Null-Modem standard cable. Maximum cable length: 10 m (33 ft).

Examples:

- Mouse extension cable - 1.80 m (6 ft); Manufacturer: Clone.
- Belkin pro series DB9 serial extension cable 5 m (17 ft); Manufacturer: Belkin.
- Cables Unlimited PCM195006 cable, 6 ft DB9 m/f; Manufacturer: Cables Unlimited.

(5) Refer to the Section 8.7 CONDUIT KIT IP21 on page 8-16 for more details.

8 TECHNICAL SPECIFICATIONS

This chapter describes the technical specifications (electric and mechanical) of CFW-11 models.

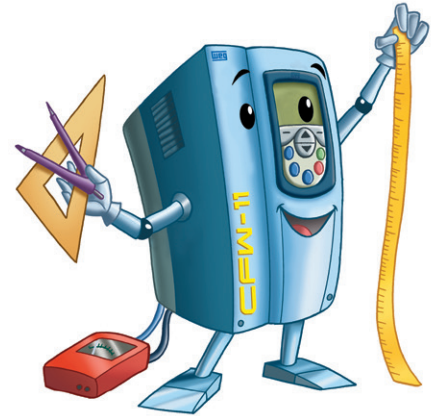

8.1 POWER DATA

Power supply:

- ☑ Voltage tolerance: -15 % to +10 % of the nominal voltage.
- ☑ Frequency: 50/60 Hz (48 Hz to 62 Hz).
- ☑ Phase imbalance: ≤ 3 % of the rated phase-to-phase input voltage.
- ☑ Overvoltage according to Category III (EN 61010/UL 508C).
- ☑ Transient voltage according to Category III.
- ☑ Maximum of 60 connections per hour.
- ☑ Efficiency: according to class IE2 as per EN 50598-2.
- ☑ Power factor (valid for rated condition):
 - 0.94 for models with three-phase power supply.
 - 0.70 for models with single-phase power supply.
- ☑ Displacement factor ($\cos \varphi$): > 0.98 .

Table 8.1 - Technical specification for the CFW-11 series

Model	Frame Size	Number of Power Phases	Use With Normal Duty (ND) Cycle										Use With Heavy Duty (HD) Cycle										Surrounding Air Temperature (1)	Dynamic Braking	Weight [kg/lb]	Degree of Protection of Cabinet	RFI Filter Suppressor	Safety Stop	24 Vdc External Control Power Supply
			Overload Current (2) [Arms]		Rated Switching Frequency (3) [kHz]	Maximum Motor (4) [CV/kW]	Rated Input Current [Arms]	Dissipated Power [W]		Rated Output Current (1) [Arms]	Overload Current (2) [Arms]	Rated Switching Frequency (3) [kHz]	Maximum Motor (4) [CV/kW]	Rated Input Current [Arms]	Dissipated Power [W]														
			1 min	3 s				Surface Mounting (6)	Flange Mounting (7)						1 min	3 s	Surface Mounting (6)	Flange Mounting (7)											
CFW11 0006 B2	A (IP21/ Nema1) and B (IP55)	1ø / 3ø	6.0	6.60	9.00	5	1.5/1.1	12.3/6.0	5	5.0	7.50	10.0	5	1.5/1.1	10.3/5.0	120	25	5.7/12.6	17/37.5	Yes (*)	Yes	24 Vdc External Control Power Supply							
CFW11 0006 S2 O FA		1ø	6.0	6.60	9.00	5	1.5/1.1	12.3	5	5.0	7.50	10.0	5	1.5/1.1	10.3	120	25	5.7/12.6	17/37.5	Built-in	Yes (*)								
CFW11 0007 T2		3ø	7.0	7.70	10.5	5	2/1.5	7.0	5.5	8.25	11.0	5	1.5/1.1	5.5	120	25	5.7/12.6	17/37.5	Yes (*)	Yes (*)									
CFW11 0007 B2		1ø / 3ø	7.0	7.70	10.5	5	2/1.5	14.4/7.0	7.0	10.5	14.0	5	2/1.5	14.4/7.0	140	25	6.1/13.4	17/37.5	Built-in	Yes (*)									
CFW11 0007 S2 O FA		1ø	7.0	7.70	10.5	5	2/1.5	14.4	7.0	10.5	14.0	5	2/1.5	14.4	140	25	6.1/13.4	17/37.5		Yes (*)									
CFW11 0010 T2		3ø	10	11.0	15.0	5	3/2.2	10.0	8.0	12.0	16.0	5	2/1.5	8.0	170	30	5.7/12.6	17/37.5		Yes (*)									
CFW11 0010 S2		1ø	10	11.0	15.0	5	3/2.2	20.5	10	15.0	20.0	5	3/2.2	20.5	140	25	6.1/13.4	17/37.5		Yes (*)									
CFW11 0013 T2		3ø	13	14.3	19.5	5	4/3.0	13.0	11	16.5	22.0	5	3/2.2	11.0	170	30	6.1/13.4	17/37.5		Yes (*)									
CFW11 0016 T2		3ø	16	17.6	24.0	5	5/3.7	16.0	13	19.5	26.0	5	4/3.0	13.0	190	30	6.1/13.4	17/37.5		Yes (*)									
CFW11 0024 T2	B	3ø	24	26.4	36.0	5	7.5/5.5	24.0	20	30.0	40.0	5	6/4.5	20.0	250	40	9.1/20	17/37.5		Yes (*)	Yes								
CFW11 0028 T2		3ø	28	30.8	42.0	5	10/7.5	28.0	24	36.0	48.0	5	7.5/5.5	24.0	290	40	9.1/20	17/37.5		Yes (*)									
CFW11 0033 T2		3ø	33.5	36.9	50.3	5	12.5/9.2	33.5	28	42.0	56.0	5	10/7.5	28.0	350	50	9.1/20	17/37.5		Yes (*)									
CFW11 0045 T2	C	3ø	45	49.5	67.5	5	15/11	45.0	36	54.0	72.0	5	12.5/9.2	36.0	450	70	15.6/34.4	30/66.2		Yes (*)									
CFW11 0054 T2		3ø	54	59.4	81.0	5	20/15	54.0	45	67.5	90.0	5	15/11	45.0	540	80	16.0/35.3	30/66.2		Yes (*)									
CFW11 0070 T2		3ø	70	77.0	105	5	25/18.5	70.0	56	84.0	112	5	20/15	56.0	680	100	17.9/39.5	30/66.2		Yes (*)									
CFW11 0086 T2	D	3ø	86	94.6	129	5	30/22	86.0	70	105	140	5	25/18.5	70.0	740	110	29.5/65.1	49/108		Yes (*)									
CFW11 0105 T2		3ø	105	116	158	5	40/30	105.0	86	129	172	5	30/22	86.0	920	140	31.4/69.2	49/108		Yes (*)									
CFW11 0003 T4	A (IP21/ Nema1) and B (IP55)	3ø	3.6	3.96	5.40	5	2/1.5	3.6	3.6	5.40	7.20	5	2/1.5	3.6	110	25	5.7/12.6	17/37.5		Yes (*)									
CFW11 0005 T4		3ø	5.0	5.50	7.50	5	3/2.2	5.0	5.0	7.50	10.0	5	3/2.2	5.0	140	25	5.9/13	17/37.5		Yes (*)									
CFW11 0007 T4		3ø	7.0	7.7	10.5	5	4/3	7.0	5.5	8.25	11.0	5	3/2.2	5.5	140	25	5.9/13	17/37.5		Yes (*)									
CFW11 0010 T4		3ø	10	11.0	15.0	5	6/4.5	10.0	10	15.0	20.0	5	6/4.5	10.0	200	30	6.1/13.4	17/37.5		Yes (*)									
CFW11 0013 T4		3ø	13.5	14.9	20.3	5	7.5/5.5	13.5	11	16.5	22.0	5	6/4.5	11.0	220	30	6.3/13.9	17/37.5		Yes (*)									
CFW11 0017 T4	B	3ø	17	18.7	25.5	5	10/7.5	17.0	13.5	20.3	27.0	5	7.5/5.5	13.5	270	40	9.1/20	17/37.5		Yes (*)									
CFW11 0024 T4		3ø	24	26.4	36.0	5	15/11	24.0	19	28.5	38.0	5	10/7.5	19.0	360	50	9.7/21.4	17/37.5		Yes (*)									
CFW11 0031 T4		3ø	31	34.1	46.5	5	20/15	31.0	25	37.5	50.0	5	15/11	25.0	430	60	10.4/22.9	17/37.5		Yes (*)									
CFW11 0038 T4	C	3ø	38	41.8	57.0	5	25/18.5	38.0	33	49.5	66.0	5	20/15	33.0	590	90	16.4/36.2	30/66.2		Yes (*)									
CFW11 0045 T4		3ø	45	49.5	67.5	5	30/22	45.0	38	57.0	76.0	5	25/18.5	38.0	650	100	19.6/43.2	30/66.2		Yes (*)									
CFW11 0058 T4		3ø	58.5	64.4	87.8	5	40/30	58.5	47	70.5	94.0	5	30/22	47.0	800	120	20.5/45.2	30/66.2		Yes (*)									
CFW11 0070 T4		3ø	70.5	77.6	106	5	50/37	70.5	61	91.5	122	5	40/30	61.0	1050	160	31.1/68.6	49/108		Yes (*)									
CFW11 0088 T4		3ø	88	96.8	132	5	60/45	88.0	73	110	146	5	50/37	73.0	1170	180	32.6/71.8	49/108		Yes (*)									

Models with 200...240 V power supply

Models with 380...480 V power supply

The notes for Table 8.1 on page 8-2 to Table 8.2 on page 8-3 are located after the Table 8.2 on page 8-3.

Table 8.2 - Specification for the CFW-11 series with a carrier frequency of 10 kHz (important: only valid for inverters with degree of protection IP2X/Nema1)

Model	Frame Size	Number of power phases	Carrier Frequency of 10 kHz and Surrounding Air Temperature = 50 °C (122 °F)											Carrier Frequency of 10 kHz and Surrounding Air Temperature = 40 °C (104 °F)										
			Use with Normal Duty (ND) Cycle					Use with Heavy Duty (HD) Cycle					Use with Normal Duty (ND) Cycle					Use with Heavy Duty (HD) Cycle						
			Number of power phases (1) [Arms]	Maximum Motor (4) [CV/kW]	Rated Input Current [Arms]	Disipated Power [W] Surface Mounting (6) Flange Mounting (7)	Rated Output Current (1) [Arms]	Overload Current (1) [Arms] 1 min 3 s	Maximum Motor (1) [CV/kW]	Rated Input Current [Arms]	Disipated Power [W] Surface Mounting (6) Flange Mounting (7)	Number of power phases (2) [Arms] 1 min 3 s	Maximum Motor (4) [CV/kW]	Rated Input Current [Arms]	Disipated Power [W] Surface Mounting (6) Flange Mounting (7)	Rated Output Current (1) [Arms]	Overload Current (2) [Arms] 1 min 3 s	Maximum Motor (4) [CV/kW]	Rated Input Current [Arms]	Disipated Power [W] Surface Mounting (6) Flange Mounting (7)				
CFW11 0006 B 2	A	1 φ / 3 φ	5.5	6.05	8.25	1.5/1.1	11.3/5.5 (5)	4.6	140	25	6.0	2/1.5	123/6.0	500	7.50	100	1.5/1.1	10.3/5.0	130	25				
CFW11 0006 S 2	O FA	1 φ	5.5	6.05	8.25	1.5/1.1	11.3	4.6	140	25	6.0	2/1.5	123	500	7.50	100	1.5/1.1	10.3	130	25				
CFW11 0007 T 2		3 φ	6.2	6.82	9.30	2/1.5	6.2	4.9	140	25	7.0	2/1.5	7.0	550	8.3	11.0	1.5/1.1	5.5	130	25				
CFW11 0007 B 2		1 φ / 3 φ	6.6	7.26	9.90	2/1.5	13.5/6.6 (5)	6.6	140	25	7.0	2/1.5	14.4/7.0	690	10.4	138	2/1.5	14.1/6.9	150	25				
CFW11 0007 S 2	O FA	1 φ	7.0	7.26	9.90	2/1.5	14.35	6.6	140	25	7.0	2/1.5	14.35	690	10.4	138	2/1.5	14.15	150	25				
CFW11 0010 S 2		1 φ	8.0	8.80	12.00	2/1.5	16.4	8.0	160	25	9.40	3/2.2	193	940	14.1	188	3/2.2	193	180	30				
CFW11 0010 T 2		3 φ	8.4	9.24	12.6	2/1.5	8.4	6.7	140	25	10.0	3/2.2	100	800	12.0	160	2/1.5	80	160	25				
CFW11 0013 T 2		3 φ	9.8	10.8	14.7	3/2.2	9.8	8.3	180	30	10.7	3/2.2	10.7	900	13.5	180	3/2.2	90	170	30				
CFW11 0016 T 2		3 φ	12.8	14.1	19.2	4/3.0	12.8	10.4	210	30	14.6	5/3.7	14.6	120	18.0	240	4/3	120	200	30				
CFW11 0024 T 2	B	3 φ	23.0	25.3	34.5	7.5/5.5	23.0	19.2	320	50	23.8	7.5/5.5	23.8	199	29.9	39.8	7.5/5.5	199	280	40				
CFW11 0028 T 2		3 φ	23.0	25.3	34.5	7.5/5.5	23.0	19.2	330	50	23.8	7.5/5.5	23.8	204	30.6	40.8	7.5/5.5	204	300	50				
CFW11 0033 T 2		3 φ	25.2	27.7	37.8	7.5/5.5	25.2	36.0	360	50	27.5	10/7.5	27.5	230	34.5	46.0	7.5/5.5	230	330	50				
CFW11 0045 T 2	C	3 φ	36.6	40.3	54.9	12.5/9.2	36.6	54.0	540	80	39.3	15/11	39.3	314	47.1	62.8	10/7.5	314	470	70				
CFW11 0054 T 2		3 φ	43.2	47.5	64.8	15/11	43.2	60.0	600	90	47.0	15/11	47.0	393	59.0	78.6	15/11	393	550	80				
CFW11 0070 T 2		3 φ	38.5	42.4	57.8	12.5/9.2	38.5	56.0	560	80	42.0	12.5/9.2	42.0	336	50.4	67.2	12.5/9.2	336	500	80				
CFW11 0086 T 2	D	3 φ	68.8	75.7	103	25/18.5	68.8	100	770	120	75.7	30/22	75.7	616	92.4	123	20/15	616	700	110				
CFW11 0105 T 2		3 φ	84.0	92.4	126	30/22	84.0	120	930	140	96.4	30/22	96.4	790	119	158	30/22	790	870	130				
CFW11 0003 T 4	A	3 φ	3.6	3.96	5.40	2/1.5	3.6	3.6	140	25	3.60	2/1.5	3.6	3.60	5.40	7.20	2/1.5	3.6	140	25				
CFW11 0005 T 4		3 φ	4.0	4.40	6.00	2/1.5	4.0	4.0	140	25	4.50	2/1.5	4.5	4.50	6.75	9.00	2/1.5	4.5	160	25				
CFW11 0007 T 4		3 φ	5.2	5.72	7.80	3/2.2	5.2	4.1	170	30	5.80	3/2.2	5.8	4.60	6.90	9.20	2/1.5	4.6	160	25				
CFW11 0010 T 4		3 φ	9.2	10.1	13.8	5/3.7	9.2	9.2	250	40	10.0	5/3.7	10.0	100	15.0	20.0	6/4.5	100	260	40				
CFW11 0013 T 4		3 φ	11.5	12.7	17.3	7.5/5.5	11.5	9.5	290	40	13.1	7.5/5.5	13.1	104	15.6	20.8	6/4.5	104	270	40				
CFW11 0017 T 4	B	3 φ	11.9	13.1	17.9	7.5/5.5	11.9	9.5	320	50	14.4	7.5/5.5	14.4	125	18.8	25.0	7.5/5.5	125	350	50				
CFW11 0024 T 4		3 φ	14.4	15.8	21.6	7.5/5.5	14.4	11.5	390	60	15.8	7.5/5.5	15.8	150	20.0	27.0	7.5/5.5	150	400	50				
CFW11 0031 T 4		3 φ	23.6	26.0	35.4	15/11	23.6	19.0	560	80	28.3	15/11	28.3	240	36.0	48.0	15/11	240	560	80				
CFW11 0038 T 4	C	3 φ	23.6	26.0	35.4	15/11	23.6	20.5	620	90	28.5	15/11	28.5	248	37.2	49.6	15/11	248	640	100				
CFW11 0045 T 4		3 φ	30.6	33.7	45.9	20/15	30.6	25.9	730	110	33.8	20/15	33.8	285	42.8	57.0	15/11	285	700	110				
CFW11 0058 T 4		3 φ	35.1	38.6	52.7	20/15	35.1	28.2	820	120	41.0	25/18.5	41.0	329	49.4	65.8	20/15	329	780	120				
CFW11 0070 T 4	D	3 φ	38.8	42.7	58.2	25/18.5	38.8	33.6	910	140	42.3	25/18.5	42.3	366	54.9	73.2	20/15	366	870	130				
CFW11 0088 T 4		3 φ	48.4	53.2	72.6	30/22	48.4	40.2	1080	160	52.6	30/22	52.6	437	65.6	87.4	30/22	437	1000	150				

Models with 200...240 V power supply

Models with 200...240 V power supply

Note for [Table 8.1 on page 8-2](#) and [Table 8.2 on page 8-3](#):

- 1 ϕ = single-phase power supply, 3 ϕ = three-phase power supply

(*) This model with the optional RFI filter has single-phase power supply only.

(1) Rated current in permanent duty under the following conditions:

- Recommended switching frequencies. For operation with switching frequencies of 10 kHz, it is necessary a derating of the rated output current according to [Table 8.2 on page 8-3](#).

- Ambient temperature around the inverter: -10 °C to 50 °C (14 °F to 122 °F) for inverters with degree of protection IP2X/Nema1 and -10 °C to 40 °C (14 °F to 104 °F) for inverters with degree of protection IP55. For operation of the inverter in environments with higher ambient temperatures around the inverter, refer to [Item 3.3.1 Installation on page 3-38](#).

- Air relative humidity: 5 % to 95 % non-condensing.

- Altitude: 1000 m (3.300 ft); above 1000 m (3.300 ft) up to 4000 m (13.200 ft), output current derating of 1 % for each 100 m (330 ft) above 1000 m (3.300 ft).

- From 2000 m (6.600 ft) to 4000 m (13.200 ft) - maximum voltage (240 V for models 220...240 V and 480 V for models 380...480 V) derating of 1.1 % for each 100 m (330 ft) above 2000 m (6.600 ft).

- Note that the derating specified in the items above also apply to the dynamic braking IGBT (column effective braking current ($I_{\text{effective}}$) of [Table 3.4 on page 3-22](#)).

- Environment with pollution degree 2 (as per EN50178 and UL 508C).

(2) [Table 8.1 on page 8-2](#) presents only two points of the overload curve (actuation time of 1 min and 3 s). The complete overload curves of the IGBTs for ND and HD are presented in [Figure 8.1 on page 8-5](#).

(3) The switching frequency may be automatically reduced to 2.5 kHz, depending on the operating conditions (ambient temperature around the inverter, output current, etc.) - if P0350 = 0 or 1.

(4) The motor outputs are only reference values for WEG 4-pole motors of 220 V or 440 V. The correct sizing of the VSD must be done according to the rated current of the motors used.

(5) On the models with single-phase or three-phase power supply, the input current is presented for both cases. The input current for single-phase power supply is presented first.

(6) The specified losses are valid for the nominal operating conditions, that is, for the rated output current and switching frequency. Exception: the values contained in [Table 8.2 on page 8-3](#) are for switching frequency of 10 kHz and the current specified in this table.

(7) The dissipated power for flange mounting corresponds to the total losses of the inverter minus the losses on the power modules (IGBT and rectifier).

(8) For the inverter to be supplied with such optional item, it is necessary to specify it in the inverter smart code - exception:

The RFI filter is built-in on models CFW110006S2OFA and CFW110007S2OFA. For further details, refer to [Chapter 2 GENERAL INSTRUCTIONS on page 2-1](#).

(9) It is not possible to have simultaneously the optional items Nema1 and Safety Stop function on CFW11 inverters of frame size A.

(10) - Ambient temperature around the inverter: -10 to 40 °C (14 °F to 104 °F).

- Air relative humidity: 5 % to 95 % non-condensing.

- Altitude: 1000 m (3.300 ft); above 1000 m (3.300 ft) up to 4000 m (13.200 ft), output current derating of 1% for each 100 m (330 ft) above 1000 m (3.300 ft).

- Environment with pollution degree 2 (as per EN50178 and UL 508C).

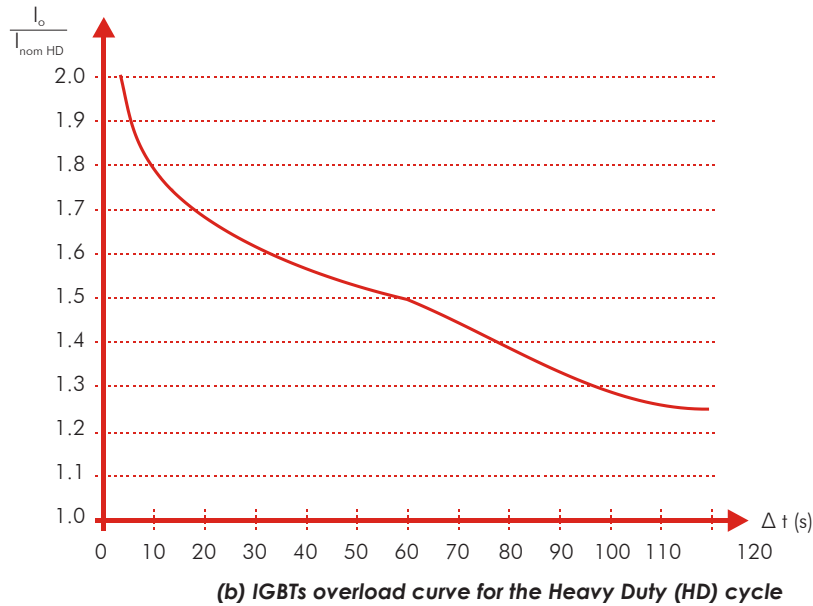
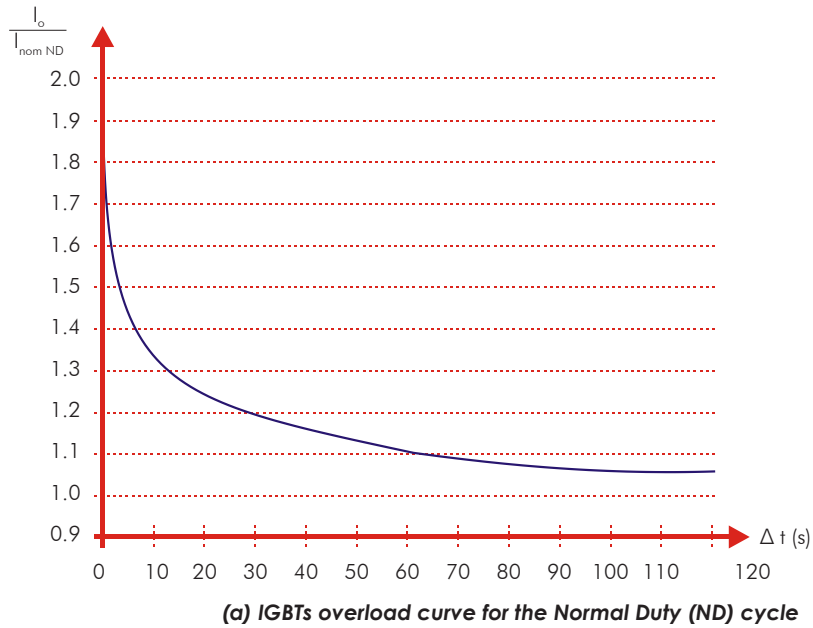

Figure 8.1 - (a) and (b) - Overload curves for the IGBTs



NOTE!

Depending on the inverter usage conditions (surrounding air temperature, output frequency, possibility or not of reducing the carrier frequency, etc.), the maximum time for operation of the inverter with overload may be reduced.

8.2 ELECTRICAL/GENERAL SPECIFICATIONS

Control	Method	<ul style="list-style-type: none"> <input checked="" type="checkbox"/> Voltage source <input checked="" type="checkbox"/> Type of control: <ul style="list-style-type: none"> - V/f (Scalar). - VVW: Voltage Vector Control - Vector control with encoder - Sensorless vector control (without encoder) <input checked="" type="checkbox"/> PWM SVM (Space Vector Modulation) <input checked="" type="checkbox"/> Full digital (software) current, flux, and speed regulators Execution rate: <ul style="list-style-type: none"> - current regulators: 0.2 ms (5 kHz) - flux regulator: 0.4 ms (2.5 kHz) - speed regulator/speed measurement: 1.2 ms
	Output Frequency	<ul style="list-style-type: none"> <input checked="" type="checkbox"/> 0 to 3.4 x rated motor frequency (P0403). The rated frequency is programmable from 0 Hz to 300 Hz in the scalar mode and from 30 Hz to 120 Hz in the vector mode <input checked="" type="checkbox"/> Output frequency limits as a function of the switching frequency: <ul style="list-style-type: none"> 125 Hz (switching frequency = 1.25 kHz) 200 Hz (switching frequency = 2.0 kHz) 250 Hz (switching frequency = 2.5 kHz) 500 Hz (switching frequency = 5 kHz) 1000 Hz (switching frequency = 10 kHz)
Performance	Speed Control	<p><u>V/f (Scalar):</u></p> <ul style="list-style-type: none"> <input checked="" type="checkbox"/> Regulation (with slip compensation): 1 % of the rated speed <input checked="" type="checkbox"/> Speed variation range: 1:20 <p><u>VVW:</u></p> <ul style="list-style-type: none"> <input checked="" type="checkbox"/> Regulation: 1 % of the rated speed <input checked="" type="checkbox"/> Speed variation range: 1:30 <p><u>Sensorless (P0202 = 3 asynchronous motor):</u></p> <ul style="list-style-type: none"> <input checked="" type="checkbox"/> Regulation: 0.5 % of the rated speed <input checked="" type="checkbox"/> Speed variation range: 1:100 <p><u>Vector with Encoder (P0202 = 4 asynchronous motor or P0202 = 6 permanent magnet):</u></p> <ul style="list-style-type: none"> <input checked="" type="checkbox"/> Regulation: <ul style="list-style-type: none"> ±0.01 % of the rated speed with a 14-bits analog input (IOA) ±0.01 % of the rated speed with a digital reference (Keypad, Serial, Fieldbus, Electronic Potentiometer, Multispeed) ±0.05 % of the rated speed with a 12-bits analog input (CC11) <input checked="" type="checkbox"/> Speed variation range: 1:1000
	Torque Control	<ul style="list-style-type: none"> <input checked="" type="checkbox"/> Range: 10 to 180 %, regulation: ±5 % of the rated torque (P0202 = 4, 6 or 7) <input checked="" type="checkbox"/> Range: 20 to 180 %, regulation: ±10 % of the rated torque (P0202 = 3, above 3 Hz)
Inputs (CC11 board)	Analog	<ul style="list-style-type: none"> <input checked="" type="checkbox"/> 2 isolated differential inputs; resolution of AI1: 12 bits, resolution of AI2: 11 bits + signal, (0 to 10) V, (0 to 20) mA or (4 to 20) mA, impedance: 400 kΩ for (0 to 10) V, 500 Ω for (0 to 20) mA or (4 to 20) mA, programmable functions
	Digital	<ul style="list-style-type: none"> <input checked="" type="checkbox"/> 6 isolated digital inputs, 24 Vdc, programmable functions
Outputs (CC11 board)	Analog	<ul style="list-style-type: none"> <input checked="" type="checkbox"/> 2 isolated analog outputs, (0 to 10) V, $R_i \geq 10 \text{ k}\Omega$ (maximum load), 0 to 20 mA / 4 to 20 mA ($R_i \leq 500 \Omega$) resolution: 11 bits, programmable functions
	Relay	<ul style="list-style-type: none"> <input checked="" type="checkbox"/> 3 relay outputs with NO/NC contacts, 240 Vac, 1 A, programmable functions
Safety	Protection	<ul style="list-style-type: none"> <input checked="" type="checkbox"/> Output overcurrent/short-circuit <input checked="" type="checkbox"/> Under/Overvoltage <input checked="" type="checkbox"/> Phase loss <input checked="" type="checkbox"/> Overtemperature <input checked="" type="checkbox"/> Braking resistor overload <input checked="" type="checkbox"/> IGBTs overload <input checked="" type="checkbox"/> Motor overload <input checked="" type="checkbox"/> External fault/alarm <input checked="" type="checkbox"/> CPU or memory fault <input checked="" type="checkbox"/> Output phase-ground short-circuit
Integral Keypad (HMI)	Standard Keypad	<ul style="list-style-type: none"> <input checked="" type="checkbox"/> 9 operator keys: Start/Stop, Up Arrow, Down Arrow, Direction of Rotation, Jog, Local/Remote, Right Soft Key and Left Soft Key <input checked="" type="checkbox"/> Graphical LCD display <input checked="" type="checkbox"/> View/edition of parameters <input checked="" type="checkbox"/> Indication accuracy: <ul style="list-style-type: none"> - current: 5 % of the rated current - speed resolution: 1 rpm <input checked="" type="checkbox"/> Possibility of remote mounting

Enclosure	IP20	<input checked="" type="checkbox"/> Models of frame sizes A, B, and C without the top cover and conduit kit
	NEMA1/IP20	<input checked="" type="checkbox"/> Models of frame size D without the IP21 kit
	IP21	<input checked="" type="checkbox"/> Models of frame sizes A, B, and C with the top cover
	NEMA1/IP21	<input checked="" type="checkbox"/> Models of frame sizes A, B, and C with the top cover and conduit kit <input checked="" type="checkbox"/> Models of frame size D with the IP21 kit
	IP54	<input checked="" type="checkbox"/> Back of the inverter (external part for flange mounting)
	IP55	<input checked="" type="checkbox"/> Models with optional 55
PC connection for inverter programming	USB connector	<input checked="" type="checkbox"/> USB standard Rev. 2.0 (basic speed) <input checked="" type="checkbox"/> Type B (device) USB plug <input checked="" type="checkbox"/> Interconnection cable: standard host/device shielded USB cable

8.3 CODES AND STANDARDS

Safety Standards	<input checked="" type="checkbox"/> UL 508C - power conversion equipment Note: Suitable for Installation in a compartment handling conditioned air <input checked="" type="checkbox"/> UL 840 - insulation coordination including clearances and creepage distances for electrical equipment <input checked="" type="checkbox"/> EN61800-5-1 - safety requirements electrical, thermal and energy <input checked="" type="checkbox"/> EN 50178 - electronic equipment for use in power installations <input checked="" type="checkbox"/> EN 60204-1 - safety of machinery. Electrical equipment of machines. part 1: general requirements. Note: The final assembler of the machine is responsible for installing an safety stop device and a supply disconnecting device <input checked="" type="checkbox"/> EN 60146 (IEC 146) - semiconductor converters <input checked="" type="checkbox"/> EN 61800-2 - adjustable speed electrical power drive systems - part 2: general requirements - rating specifications for low voltage adjustable frequency AC power drive systems
Electromagnetic Compatibility (EMC)	<input checked="" type="checkbox"/> EN 61800-3 - adjustable speed electrical power drive systems - Part 3: EMC product standard including specific test methods <input checked="" type="checkbox"/> EN 61000-4-2 - electromagnetic compatibility (EMC) - part 4: testing and measurement techniques - section 2: electrostatic discharge immunity test <input checked="" type="checkbox"/> EN 61000-4-3 - electromagnetic compatibility (EMC) - part 4: testing and measurement techniques - section 3: radiated, radio-frequency, electromagnetic field immunity test <input checked="" type="checkbox"/> EN 61000-4-4 - electromagnetic compatibility (EMC) - part 4: testing and measurement techniques - section 4: electrical fast transient/burst immunity test <input checked="" type="checkbox"/> EN 61000-4-5 - electromagnetic compatibility (EMC) - part 4: testing and measurement techniques - section 5: surge immunity test <input checked="" type="checkbox"/> EN 61000-4-6 - electromagnetic compatibility (EMC)- part 4: testing and measurement techniques - section 6: immunity to conducted disturbances, induced by radio-frequency fields <input checked="" type="checkbox"/> EN 61000-4-11 - testing and measurement techniques - Voltage dips, short interruptions and voltage variations immunity tests
Mechanical Standards	<input checked="" type="checkbox"/> EN 60529 - degrees of protection provided by enclosures (IP code) <input checked="" type="checkbox"/> UL 50 - enclosures for electrical equipment <input checked="" type="checkbox"/> IEC60721-3-3 - classification of environmental conditions - part 3: classification of groups of environmental parameters and their severities - section 3: stationary use at weatherprotected locations Level 3M4

8.4 CERTIFICATIONS

Certifications (*)	Notes
UL and cUL	E184430
CE	
IRAM	
C-Tick	
EAC	
ABS	Link: http://ww2.eagle.org/en/rules-and-resources/type-approval-database.html After accessing the link, click on "Select Option" and select "Data Search". On the new window, the certificate number must be entered on the "Certificate Number" field: 15-RJ2890495. Click on "Search".
Functional Safety	STO Funtion, with certificate issued by TÜV Rheinland.

(*) For updated information on certifications, please contact WEG.

8.5 MECHANICAL DATA

Frame Size A IP21

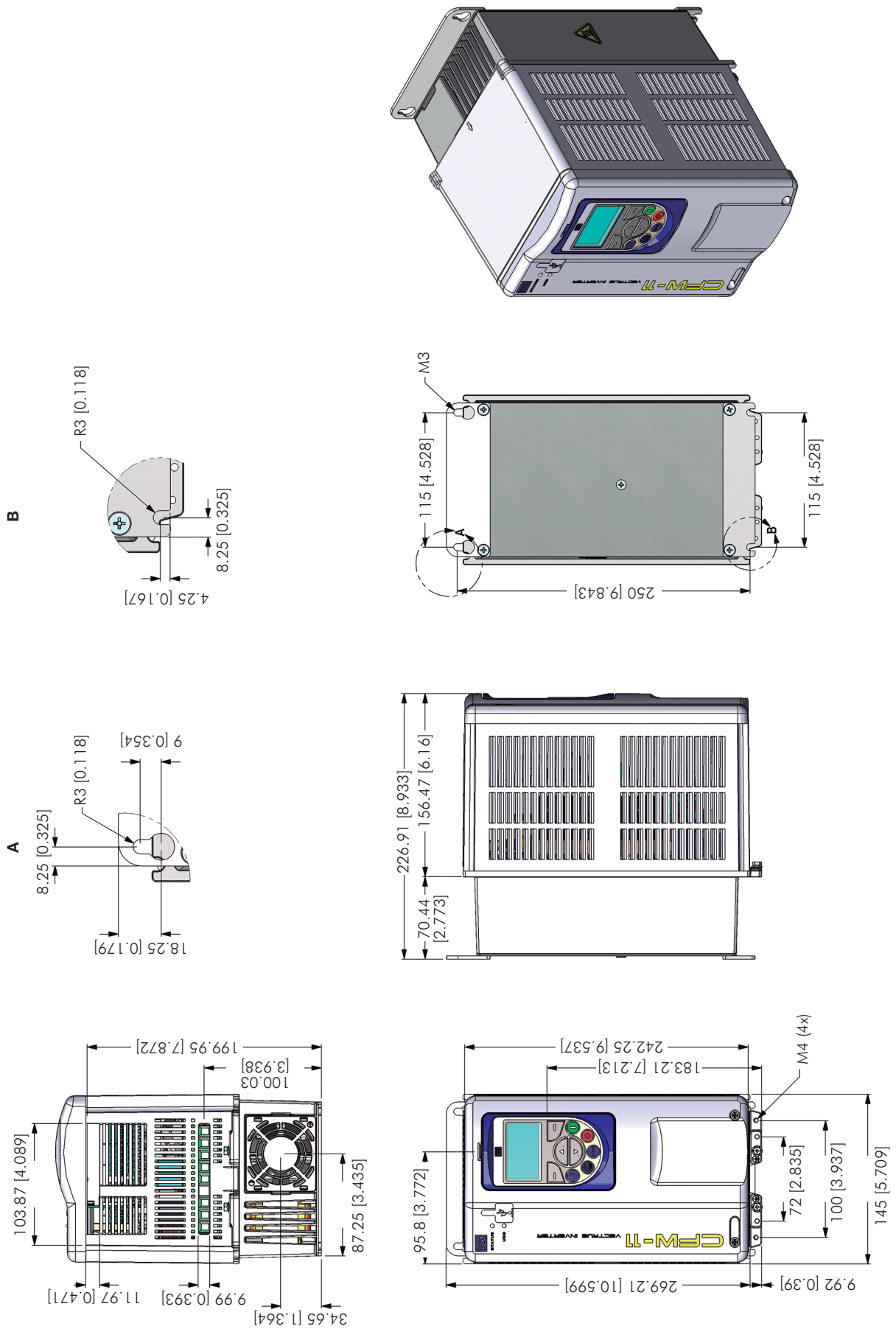

Figure 8.2 - Inverter dimensions - frame size A - mm [in]

Frame Size B IP21

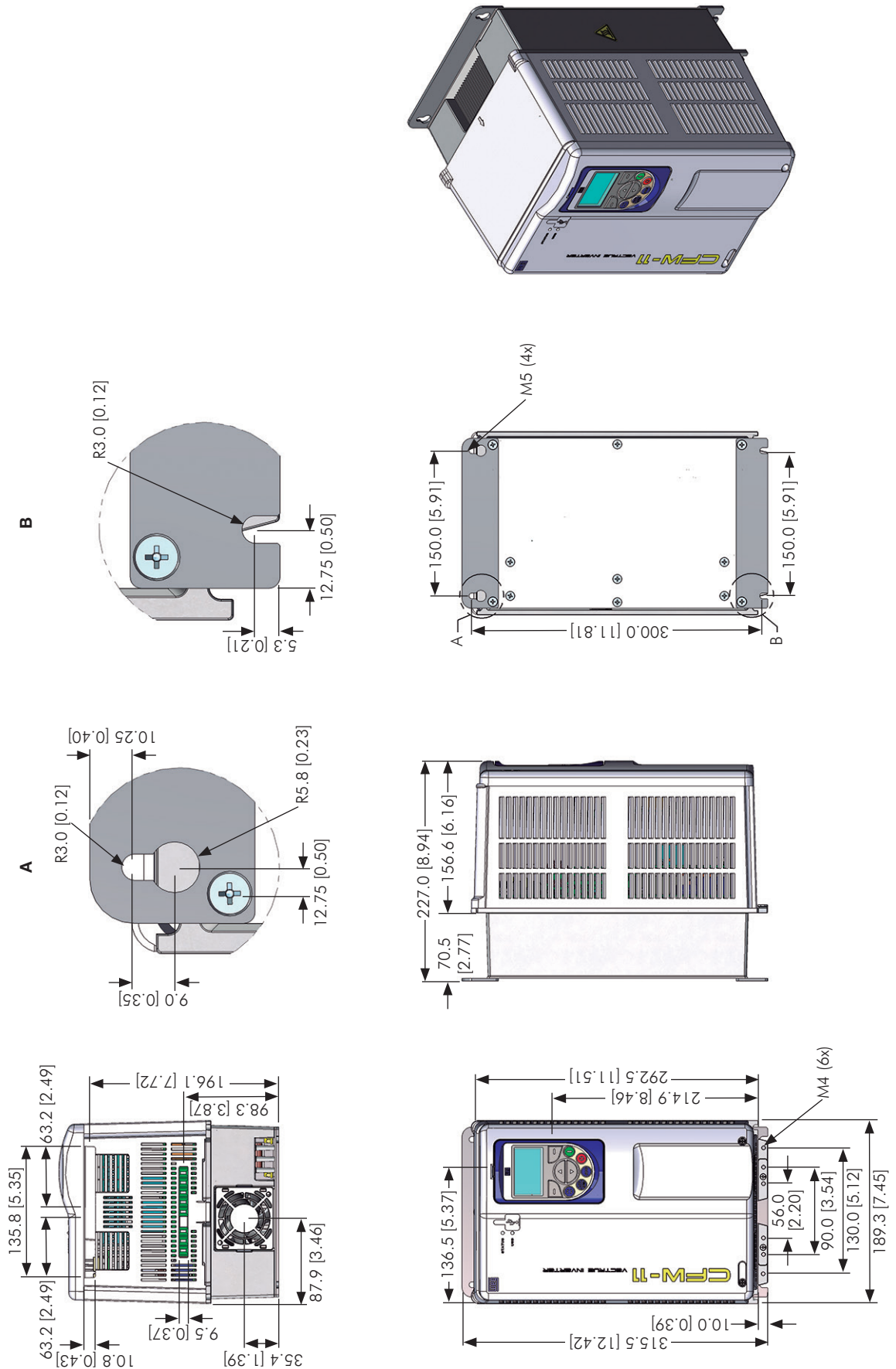

Figure 8.3 - Inverter dimensions - frame size B - mm [in]

Frame Size C IP21

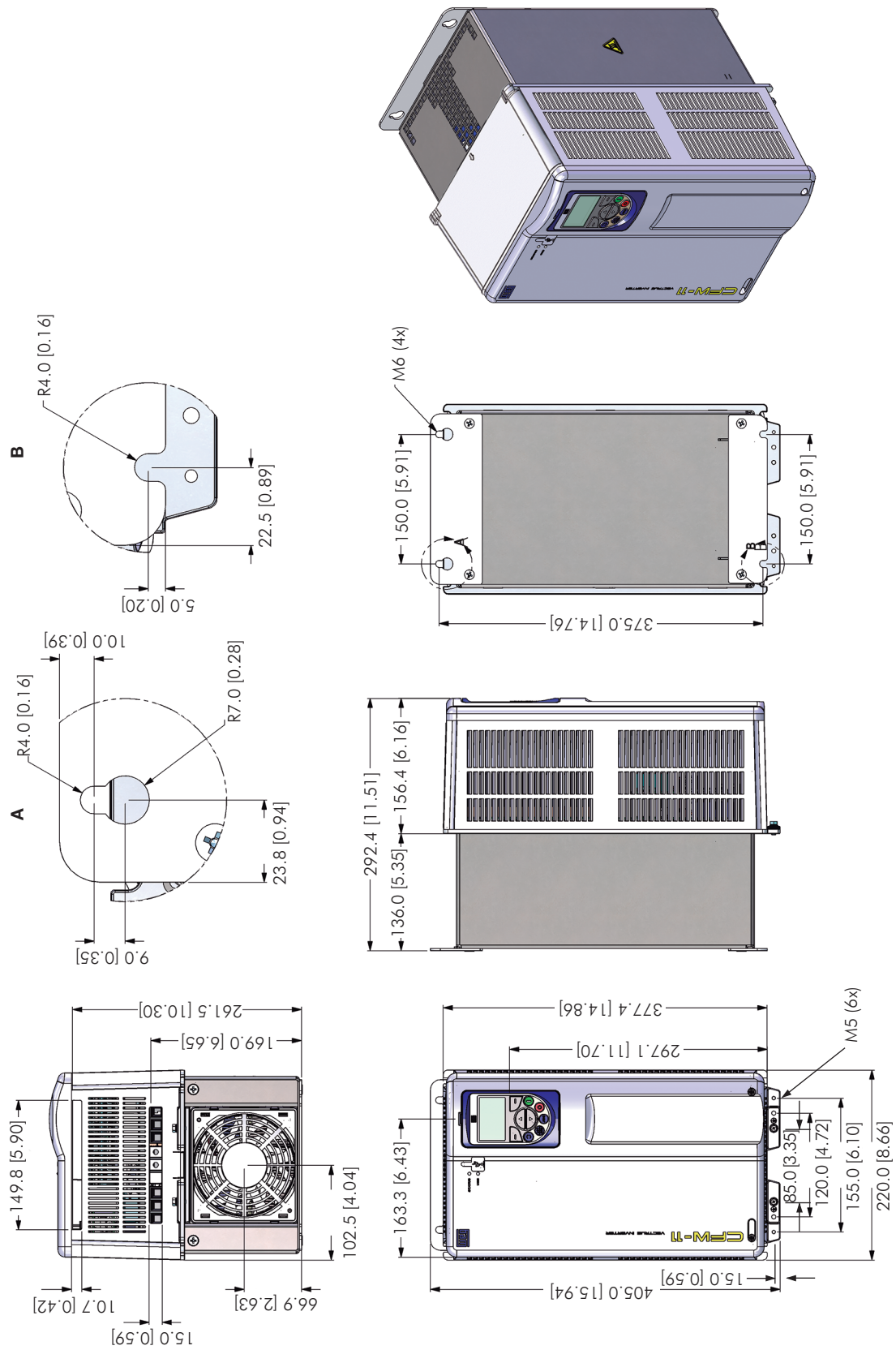

Figure 8.4 - Inverter dimensions - frame size C - mm [in]

Frame Size D IP20/Nema1

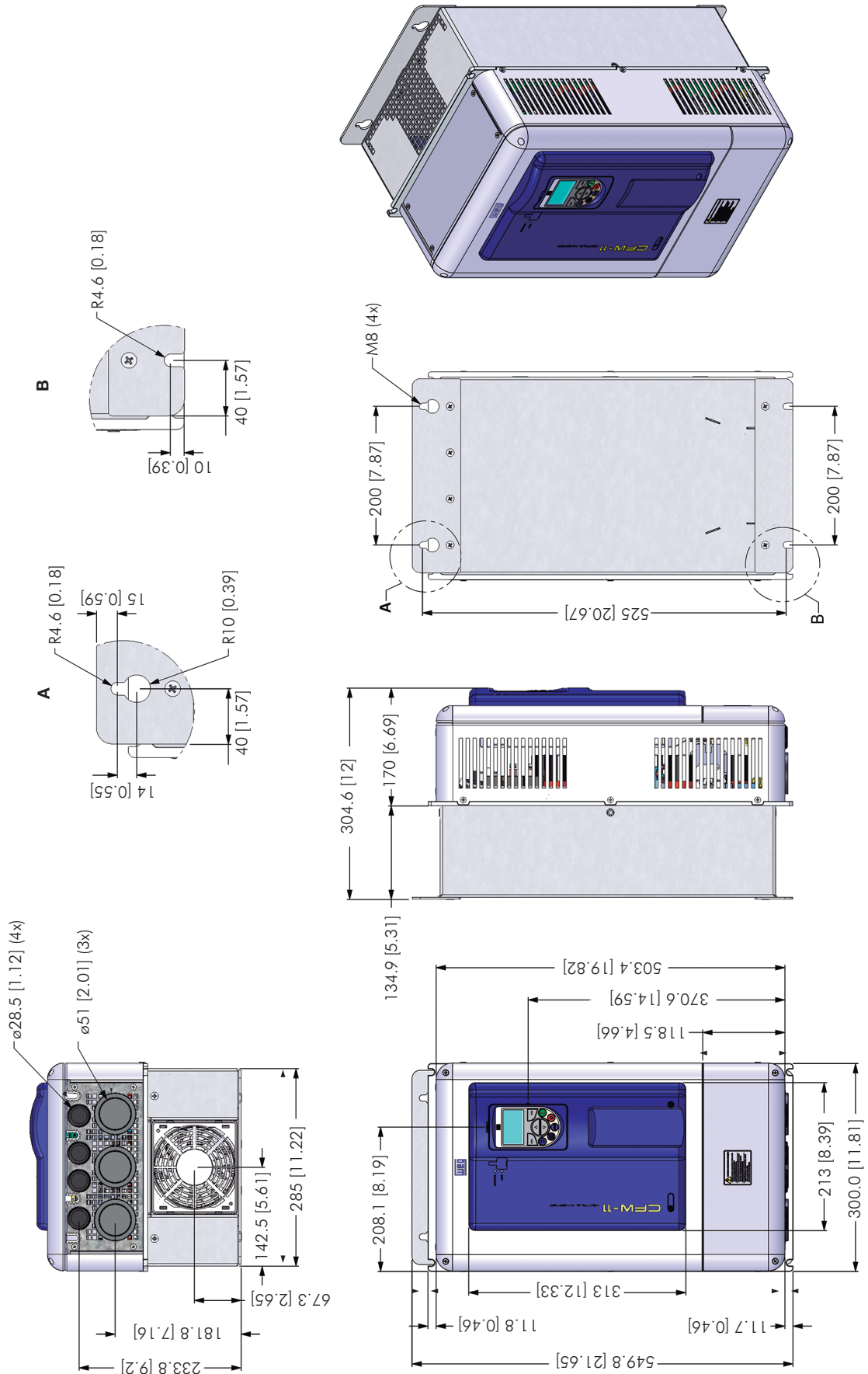

Figure 8.5 - Inverter dimensions - frame size D - mm [in]

Frame Size B IP55

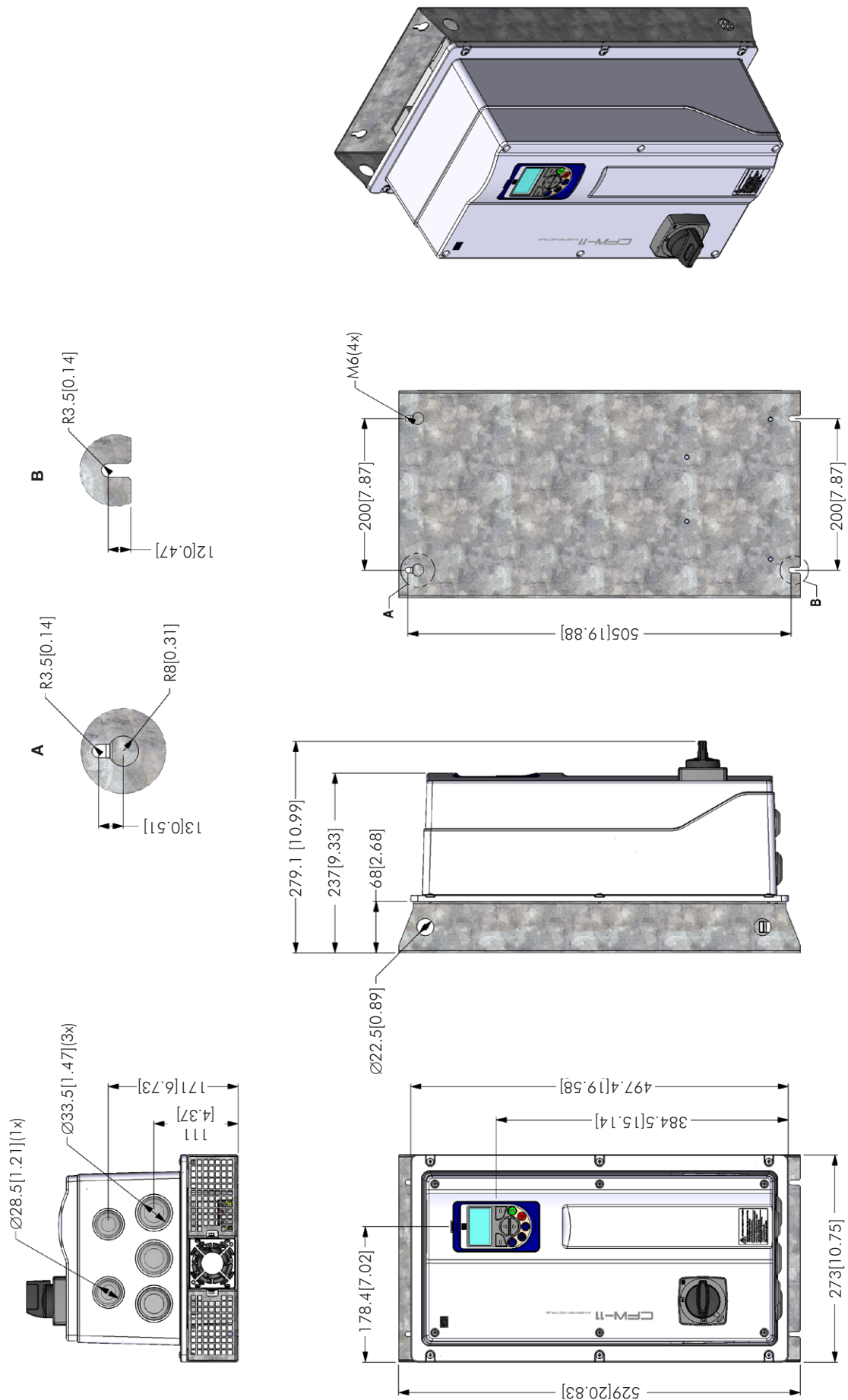

Figure 8.6 - Inverter dimensions - frame size B - mm [in]

Frame Size C IP55

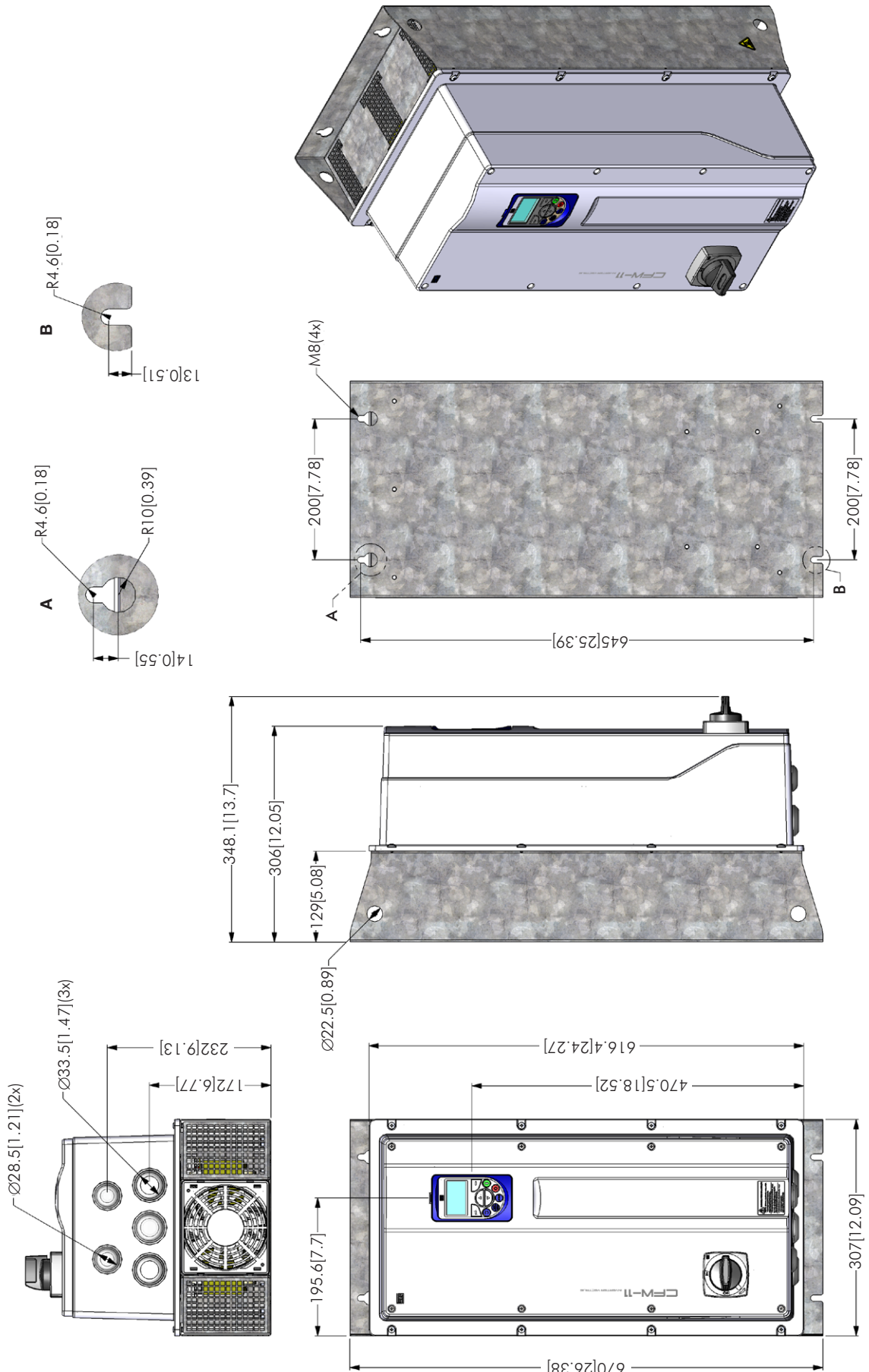

Figure 8.7 - Inverter dimensions - frame size C - mm [in]

Frame Size D IP55

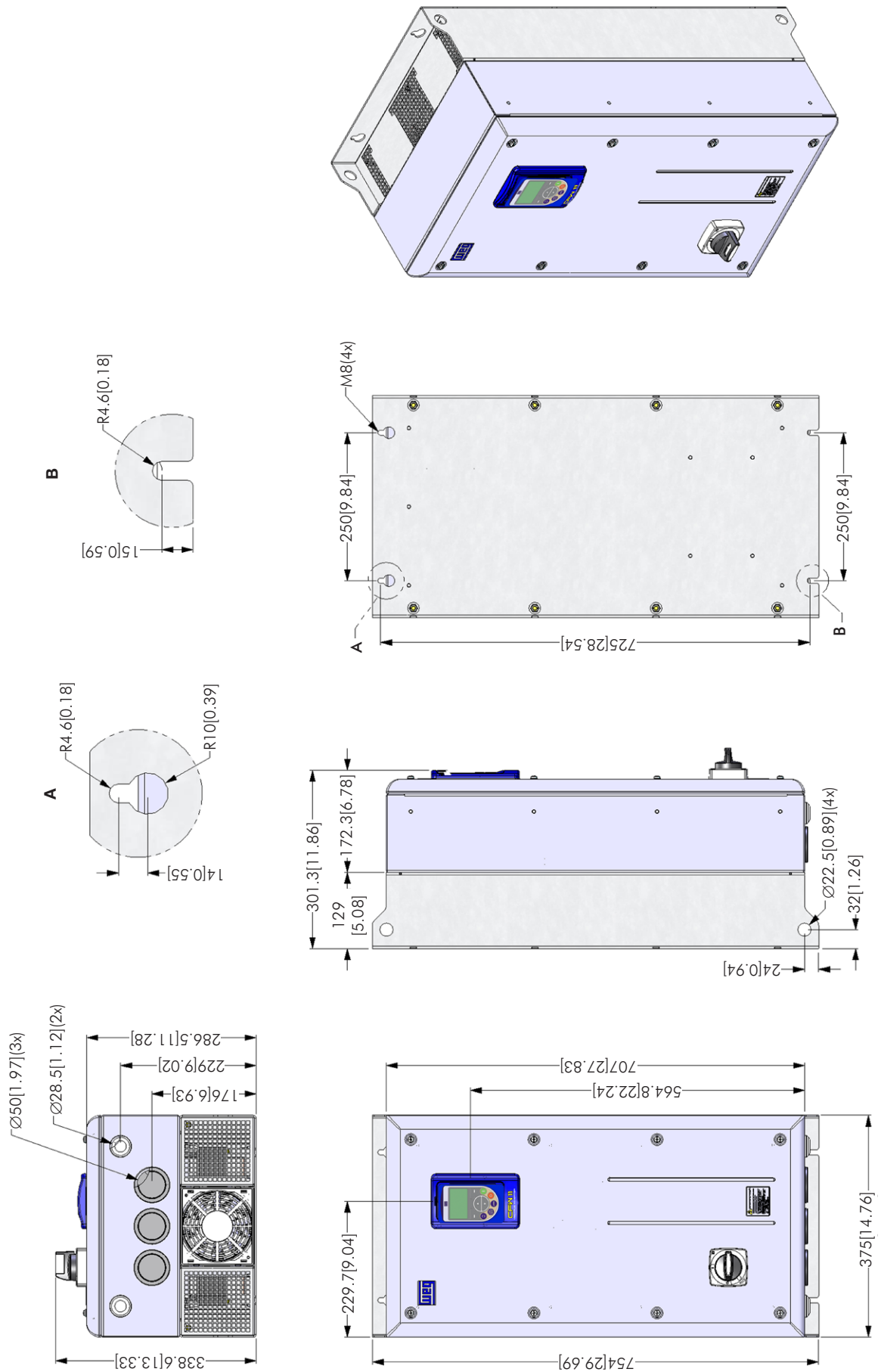
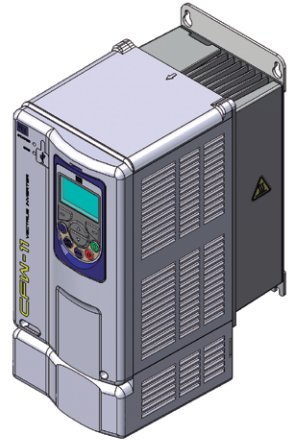
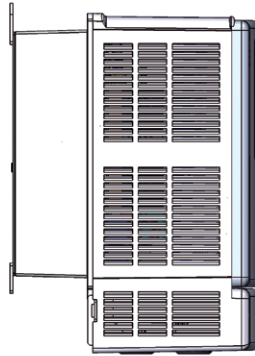
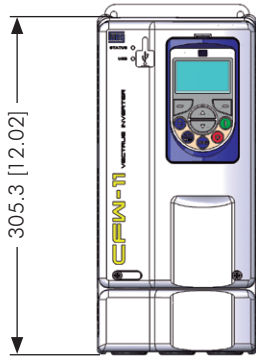

Figure 8.8 - Inverter dimensions - frame size D - mm [in]

8.6 CONDUIT KIT



- Weight of the conduit kit for frame size A: 0.8/1.8 kg/lb

(a) Frame size A with the conduit kit KN1A-01

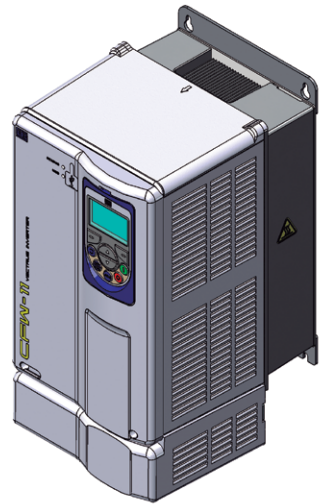
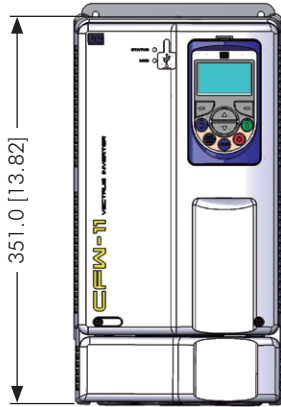

- Weight of the conduit kit for frame size B: 0.9/2.0 kg/lb

(b) Frame size B with the conduit kit KN1B-01

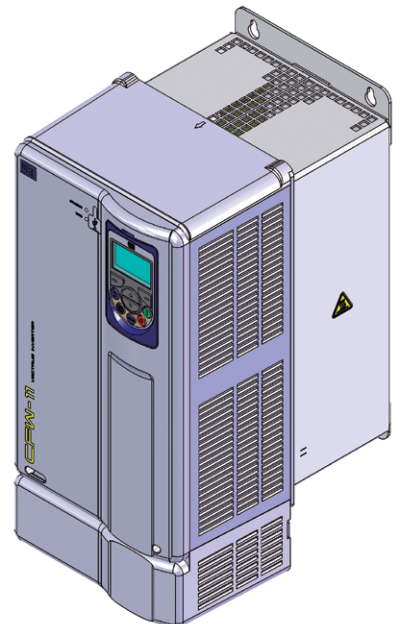
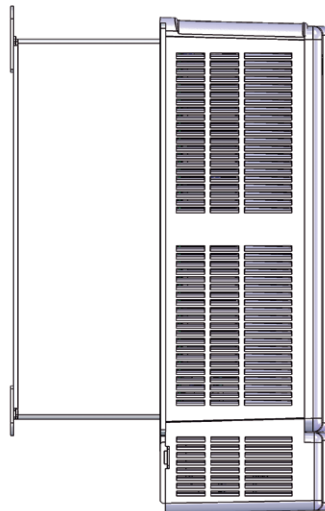
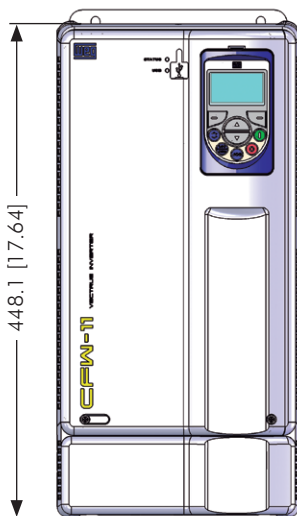

- Weight of the conduit kit for frame size C: 0.9/2.0 kg/lb

(c) Frame size C with the conduit kit KN1C-01

Figure 8.9 - (a) to (c) - Inverter dimensions with the conduit kit - mm [in]

8.7 CONDUIT KIT IP21

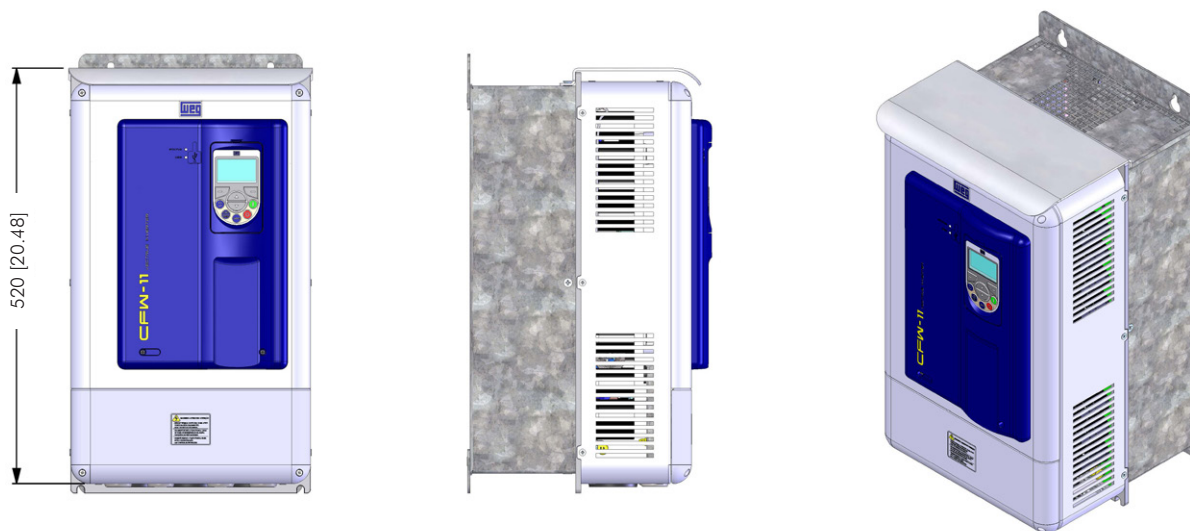

(a) Frame size A with CONDUIT KIT IP21

Figure 8.10 - Dimensions of the inverter with CONDUIT KIT IP21 - mm [in]